

SECRET

STAR WARS NOW!

The Bohm-Aharonov Effect, Scalar Interferometry, and Soviet Weaponization

T. E. Bearden

April 24, 1984

All rights reserved.

© T. E. Bearden 1984

This document is made available through the declassification efforts
and research of John Greenewald, Jr., creator of:

The Black Vault



The Black Vault is the largest online Freedom of Information Act (FOIA) document clearinghouse in the world. The research efforts here are responsible for the declassification of hundreds of thousands of pages released by the U.S. Government & Military.

Discover the Truth at: <http://www.theblackvault.com>

ACKNOWLEDGEMENT

I wish to thank Drs. Harold Faretto and Jack Dea for invaluable assistance, and basic information on building a precision scalar wave detector. In addition, I am most grateful to Mr. Hal Crawford for his marvelous special drawings and his kind permission to include them. And I owe a very special debt to Mr. John Bedini for his fundamental laboratory and bench work and his willingness to share his results and insights with me.

Also, I wish to express my deepest appreciation to Mr. Josh Reynolds, Essentia Research, and the Association of Distinguished American Scientists for financial support on this project.

Without the invaluable assistance of these persons, this effort would not have been possible.

Tom Bearden
April 23, 1984

TABLE OF CONTENTS

<u>Item</u>	<u>Title</u>	<u>page</u>
1.	Acknowledgement	i
2.	Table of Contents	ii
3.	List of Figures	ii
4.	List of Tables	iii
5.	Abstract	iii
6.	The Bohm-Aharonov Effect	1
7.	Scalar Electromagnetics	2
8.	Wireless Transmission of Energy at a Distance .	4
9.	Some Characteristics of a Scalar Wave Beam	5
10.	A Sensitive Scalar Wave Detector	7
11.	Scalar Interferometry and Weaponization	9
12.	Vacuum Theory	12
13.	Extraction of Distant Energy: A New Concept ...	12
14.	Massive Testing of "Cold Explosions"	15
15.	The Perfect Missile Shield	16
16.	Massive Soviet Weaponization	16
17.	Soviet Weather Engineering	16
18.	Conclusion	18
19.	References	24
20.	Appendix I: Typical Incidents and Related Information	26

LIST OF FIGURES

<u>Figure</u>	<u>Title</u>	<u>page</u>
1.	Scalar \bar{O} -wave production	3
2.	Creating energy at a distance	6
3.	Artist's concept of a large scalar interferometer transmitter	6
4.	Linear, uncurved laboratory frame	8
5.	Rotating the longitudinal wave produces a transverse component	8
6.	Bending the laboratory spacetime frame pro- duces a transverse component	8
7.	A Sensitive Scalar Wave Detector	8
8.	Tactical air-to-ground usage	11
9.	Ground-to-air usage	11
10.	Mushroom cloud from sea off Japan near Russian test area	13
11.	Network of virtual transmitters	19
12.	Virtual transmitters in the interference grid .	19
13.	Giant radial related to a virtual transmitter .	20
14.	Formation of a single giant radial	20
15.	Formation of a double giant radial	21
16.	Detection of transverse and longitudinal waves	21
17.	Twin giant radial pattern	22

LIST OF TABLES

<u>Table</u>	<u>Title</u>	<u>page</u>
1.	Conservation of anenergy: an expanded energy conservation law	3
2.	Mushroom cloud rising from sea	13
3.	Mushroom cloud from sea off Japan	14
4.	Plumes noted in satellite photos in Soviet Arctic (77 since 1974).....	14
5.	Khrushchev's 1960 statement	17
6.	Brezhnev's 1975 proposal	17
7.	Twin giant radials	22
8.	Radiation of the U.S. Embassy in Moscow	23
9.	Lysenko's 1982 statement	23

- ABSTRACT -

The Bohm-Aharonov Effect shows that, even in the absence of electrical and magnetic fields, the potentials cause real effects to occur in the field-free regions. Using this principle, beams of pure potential without vector force fields (without E and H fields) may be deliberately produced and intersected at a distance to cause effects in the interference zone, in contradiction to classical mechanics. These effects are in fact required by quantum mechanics.

Essentially, energy may be produced directly at the distant interference site or extracted from it, without energy transmission through space.

Implications for weapons built on these concepts are given, and several types of such scalar electromagnetics weapons are discussed. The use of the "cold explosion" is detailed and evidence of its extensive testing is given. The basic mechanism for Soviet weather control over North America is briefly presented and a more extensive reference given.

Evidence of massive Soviet weaponization of these effects for nearly three decades and of Soviet scalar electromagnetics weapons testing on a global scale exists in the open literature. Selected examples and related information are given in the Appendix.

STAR WARS NOW!

The Bohm-Aharonov Effect, Scalar Interferometry,
and Soviet Weaponization

© 1984 T. E. Bearden

- The Bohm-Aharonov Effect -

Originally electrical and magnetics experiments and ideas developed primarily in terms of statics, and great difficulty was experienced in combining the two and passing to a more dynamic theoretical representation. With the advent of Maxwell's equations, electricity and magnetism were combined into an elegant electromagnetic theory, and these equations then served as the basis for the development of modern theory. Gradually potentials were relegated to a position of inferior importance, and they even came to be regarded as purely mathematical conveniences by most scientists.

However, with the advent of Aharonov and Bohm's seminal paper [a], it became crystal clear that potentials are in fact real entities, and they can directly affect and control charged particle systems even in a region where all the fields and hence the forces on the particles have vanished. While this, of course, is completely counter to the conclusions of classical mechanics [a, p. 485], it follows inescapably from quantum mechanics. With Chambers's direct experimental proof of the predicted Bohm-Aharonov effects in 1960 [b], this new viewpoint was firmly established for quantum mechanics and quantum electromagnetics in general. Indeed, the Bohm-Aharonov effect even affects gauge theories, requiring the concept of nonintegrable phase factors and global formulation of gauge fields. [c] Thus increasingly it is the potentials that are primary physical entities, and the fields are of secondary, derived importance in modern quantum electrodynamics.

Yet the full weapon implications of the Bohm-Aharonov discovery have not yet penetrated the minds and consciousnesses of Western physicists, electrical engineers, and weapons analysts. Indeed, an extended treatment of such implications has not even been addressed in the literature. This may be somewhat understandable, since it required over 30 years for physicists to realize the primary actuality of the potentials in the first place [d, p. 15-12]. Nobelist Feynman states it succinctly: "It is interesting that something like this can be around for thirty years but, because of certain prejudices of what is and is not significant, continues to be ignored." [d, p. 15-12.]

Slowly, however, the overwhelming importance of the scalar electromagnetics indicated by Bohm and Aharonov has been noted by this analyst, and work to investigate and apply

this rich new region of quantum electrodynamics is now most certainly warranted. Indeed, it is imperative that an effort of the highest priority be mounted immediately, for our very survival is gravely threatened by scalar electromagnetics weapons already in the hands of the Soviet Union. And at this moment we have absolutely no defense whatsoever against them.

- Scalar Electromagnetics -

We first define scalar electromagnetics as the quantum mechanical effects and influences that can be accomplished by electrical and magnetic scalar potentials, even in the absence of electric and magnetic fields, or -- in other words -- that can occur even in otherwise zero-E (electric) and zero-B (magnetic) force-field regions. Note that this definition includes as subsets both the ordinary classical EM field approach and the more fundamental approach of quantum electrodynamics. In the latter approach, one replaces the fields E and B in modern theory with the ϕ (electrostatic scalar potential) and A (magnetic vector potential), with the view that these potentials create the E and B fields in the first place. The Bohm-Aharonov effect shows that the E and B fields can remain zero, and yet the potentials can still cause physical effects.

Thus scalar electromagnetics encompasses two cases: (1) the normal case, in which the potentials are viewed as first creating the fields E and B, and these force fields in turn produce physical effects on charged particle systems; and (2) the case in which fields E and B are zero, yet potentials still exist and produce physical effects on charged particle systems.

Indeed, we assume total primacy of scalar potentials, after the work of Whittaker [e], holding that all the effects of present electrodynamics can be produced by utilization and interference of two or more scalar potentials.

Note particularly that one may deliberately create the zero-field, pure potential condition by opposing magnetic and or electrical fields so that they sum to zero. (Figure 1). That is, the "zero fields" can be resultant vector zeros, where the combining vector components still exist. In this case one creates a deliberate, artificial scalar potential which contains all the energies of the separate infolded [Bohm's term] vector fields used to make the resultant vector zero. All this infolded energy has been transformed to stress of spacetime, or pure potential. (Table 1). However, it does not have a randomized substructure as is usual in quantum electrodynamics, but has a determined, known substructure consisting of the constructed infolded E and B field vectors.

Conceptually, a magnetic pole is such a spatiotemporal stress potential -- but usually with a randomized substructure -- as is an electrical charge.

Now it is fundamental that only the envelope is "observable," and the infolded substructure has become "virtual." But by having a deliberately designed and

Figure 1.

SCALAR 0-WAVE PRODUCTION

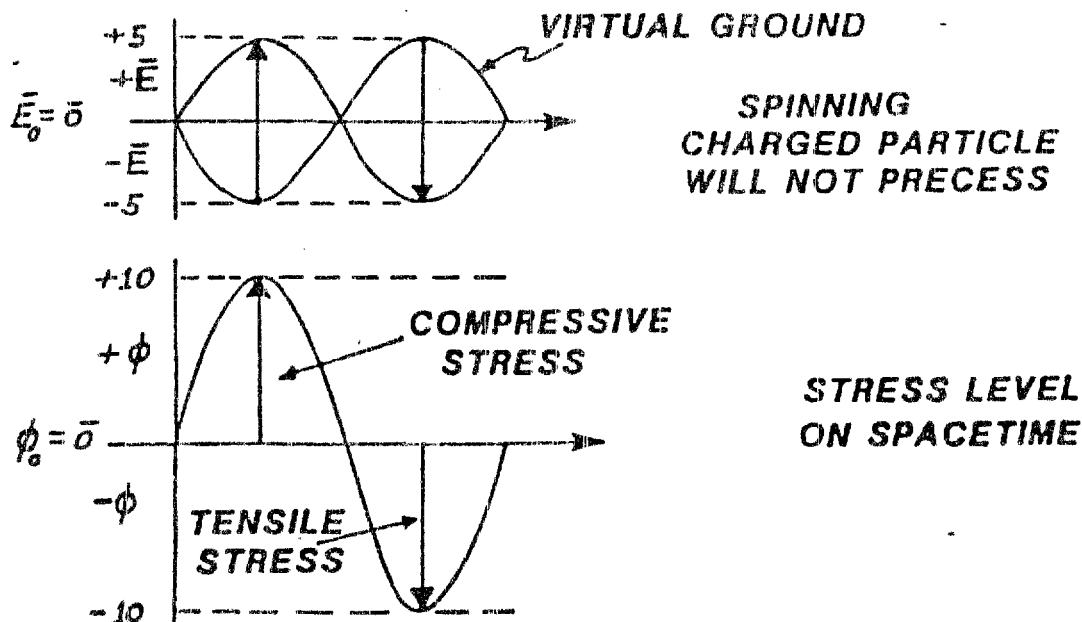

Table 1.

CONSERVATION OF ANENERGY (AE): (AN EXPANDED ENERGY CONSERVATION LAW)

1. CONSERVATION OF CHARGE:
 - "CHARGE" = MASS (M_C) + CHARGE (AE_C)
 - $|M_C| + |AE_C| = K_1$
2. CONSERVATION OF ENERGY:
 - DYNAMIC ENERGY (E)
 - ENERGY EQUIVALENCE OF MASS (M_E)
 - $|E| + |M_E| = K_2$
3. ADDING (1) AND (2):

$$|M_C| + |AE_C| + |E| + |M_E| = K_1 + K_2 = K_3$$
4. LETTING $|M| = |M_C| + |M_E|$,

$$|M| + |E| + |AE_C| = K_3$$
5. LETTING $|M| = AE_1$, $|E| = |AE_2|$, $|AE_C| = AE_3$,

$$AE_1 + AE_2 + AE_3 = K_3$$

controlled substructure, one has turned quantum mechanics inside out. One can now control and engineer the probabilities themselves, and even determine which eigenvector state of a propagating Schrödinger wave will be produced in the collapse of the wave function. Indeed, in theory one can control when the wave function collapses, and under what circumstances. Einstein was correct after all; once we discover His more subtle control mechanism, God does not actually play dice with the universe.

I strongly point out that this is a fundamental change to present quantum mechanics itself. In the axioms of quantum mechanics, the basic virtual state background activity of the universe is assumed to be totally statistical. If it can be made deterministic, then one should be able to "engineer" the presently probabilistic quantum interactions as desired. In short, one would have directly implemented David Bohm's "hidden variables" in a controlled, non-statistical manner.

Awesome implications follow from such capability; literally one can directly engineer the present quantum mechanical structure of physical reality itself, since one can engineer, affect, and control the fundamental virtual processes of nature. A potential is a "point" function, and it can be used to penetrate to any degree of fineness desired. Simply by making and utilizing artificial potentials with deliberate substructures, one can engineer the virtual particle interactions that produce all the physical forces of nature, bind the nucleus together, and control and CREATE the world of macroscopic changes, we think we inhabit.

Conceptually, a magnetic pole is such a spatiotemporal stress potential -- but usually with a randomized substructure -- as is an electrical charge.

Note also that, if one rhythmically varies all the individual summation vectors in the substructure by the same factor, one produces pure potential stress waves -- scalar waves -- without ever creating external electric and magnetic fields. These are pure waves of spacetime, and they are oscillating curvatures of spacetime itself. They are pure waves of compression and rarefaction of the massless charge of spacetime, and are properly represented as longitudinal waves rather than transverse waves. Thus they are nonHertzian in nature. Among other things, they may be used to generate mass and inertial field directly, but that is beyond the scope of this paper.

- Wireless Transmission of Energy at a Distance -

To illustrate one remarkable though typical implication of this new breakthrough area, we point out that, by changing the potentials while keeping the force-fields zero, one can directly produce energy at a distance as if it were transported through space without losses, even though no energy transmission through space in the normal fashion occurs as such. Indeed, it may even be possible to utilize pure potential waves to "transport" the energy at any

velocity -- not limited by the speed of light -- since in some cases a potential (for example, electrostatic scalar potential) can be regarded as having infinite velocity, simply appearing "everywhere at once." [f]

Electrostatic scalar potential, for example, may be regarded as a sort of "locked-in stress energy" of vacuum, as can any other vacuum potential. Changing the potential in a region or at a point changes the amount of "locked-in" or "infolded" vacuum energy available or stored in that region or at that point. Yet simply changing the potential at that point or in that region need not involve any local expenditure of work there; the work may be expended elsewhere, and the results realized directly at a distant region by a change in that region's potential, according to the Bohm-Aharonov effect. In the remote region, charged particles are imbedded in vacuum potential by their virtual particle charge flux, and in the induced potential gradients the imbedded particles move, producing electrical and magnetic forces and fields and performing work.

This is somewhat analogous to "putting energy in here" and "extracting it out there" without any travel or losses in between -- Nikola Tesla's old "wireless transmission of energy at a distance without losses" idea. Note that, quantum mechanically, we may take the view that this is a very special class of macroscopic "energy tunneling" phenomena, as illustrated in Aharonov and Bohm's original paper [a]. Essentially energy is put into the system at the locations where the scalar potentials are produced, and is recovered at the distant interference zone where, particle effects are produced (Figure 2).

To pursue this single example and further show its implications, we point out that in theory one may deliberately make a beam containing zero electric and magnetic fields, simply by properly phase-locking together two or more beams of oscillating ordinary E-H electrical energy, all at the same frequency. In the perfect hypothetical case, for example, two single-frequency beams phase-locked together 180 degrees apart would create such a zero-field or scalar-wave beam (Figure 1). In the real world, one would be phase-locking two beams containing narrow bandwidths, and how much zero-field beam is obtained at the center of the bandwidth would depend on the "Q" (sharpness) of each beam. To purify the beam, it could first be transmitted through a grounded Faraday shield, which would remove most of the orthodox E-H field components not properly zeroed. By successive Faraday "stripping" of the beam, a scalar beam as pure as desired can be obtained. Hal Crawford's artistic concept of a large scalar interferometer weapon is shown in Figure 3.

- Some Characteristics of a Scalar Wave Beam -

Such a beam is totally undetectable by a normal E-H detector, since it does not produce normal force-field-induced accelerations of particles (such as the free electron gas in an antenna or the conduction electrons

CREATING ENERGY AT A DISTANCE

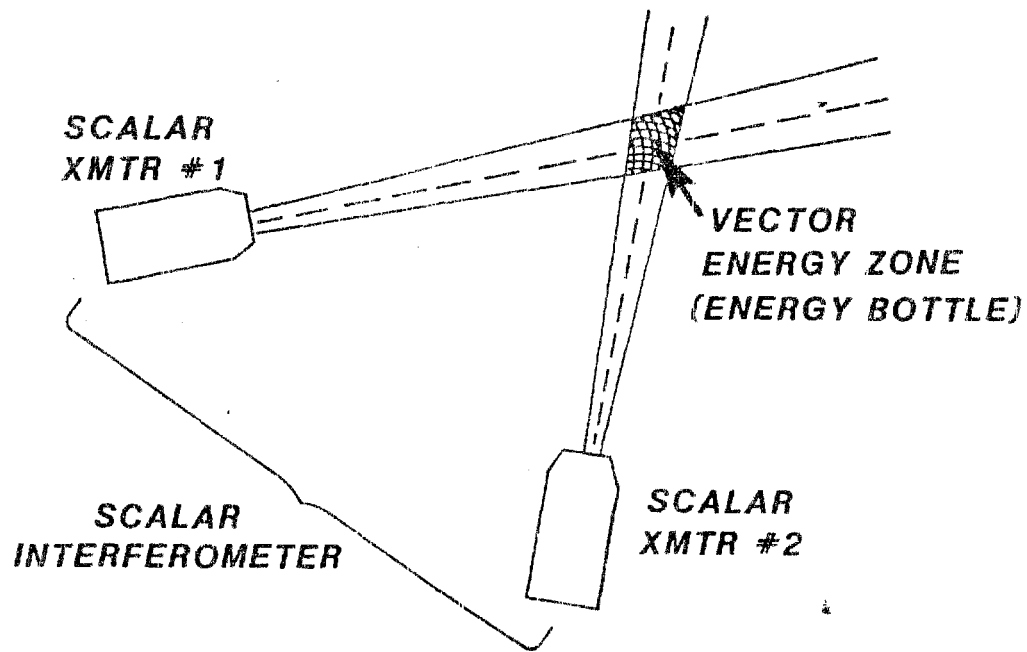
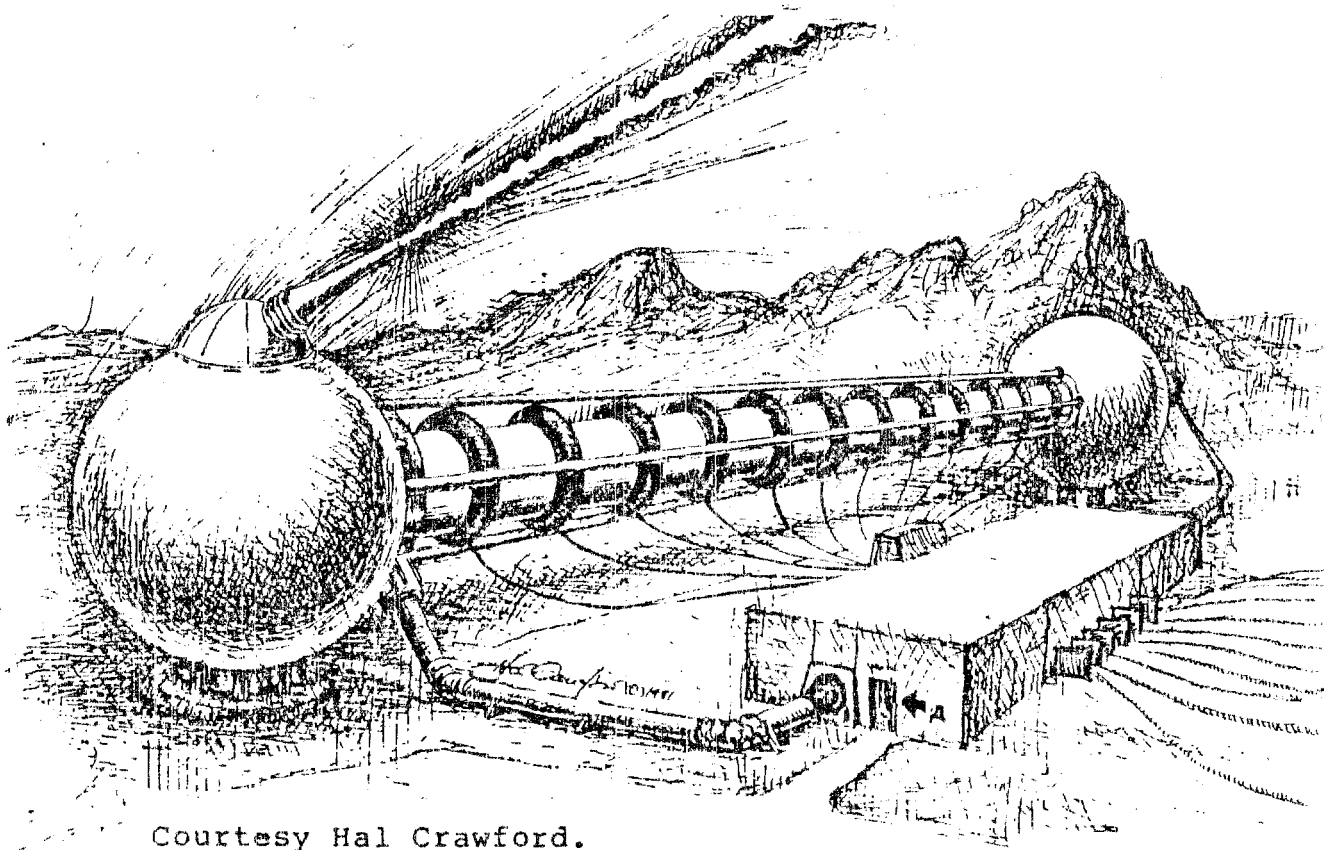

Figure 3. ARTIST'S CONCEPT OF A LARGE SCALAR INTERFEROMETER TRANSMITTER.



Courtesy Hal Crawford.

in a Faraday shield). Thus this wave is usually nondetectable except by unique detectors specifically designed to detect \emptyset and A potential in the condition of zero E and H.

This scalar beam also is capable of strong penetration of ocean water, since free ions do not absorb nearly so much of it as for an ordinary E-H field beam. Thus one may speak of megahertz and even gigahertz beams and signals transmitted through the ocean (and through the earth). In fact, an associate of the author appears to have developed a prototype underwater transmission system, including a sensitive scalar wave detector. Even an underwater radar appears quite feasible.

- A Sensitive Scalar Wave Detector -

Very briefly we present a method of making a very sensitive scalar wave detector so that direct measurement and quantization can be established.

First, we regard one oscillation (one wavelength) of the scalar potential wave as a longitudinal photon. Note that this photon contains a substructure, which may be deliberately determined (when artificially made) or randomized (when naturally made in the idealized case).

For convenience we represent normal linearized vacuum (spacetime) as a horizontal or longitudinal vector (Figure 4), implying the direction of motion of the wave in the laboratory frame. By horizontal position in our diagram, we imply a linear, uncurved spacetime and a non-rotated frame. We represent the longitudinal scalar wave as a horizontal vector, and the usual Hertzian wave as a vertical or "transverse" vector. We visualize a normal detector as detecting only a vertical or "transverse" vector, as we have illustrated in Figure 4.

As can be seen, in a linear, unrotated or uncurved spacetime a pure scalar wave has no vertical component projected upon the laboratory frame vector, so it is not detectable by normal detectors.

To detect the scalar wave, of course we could bend it so that it has a projected vertical component in the laboratory frame (Figure 5). However, this would be an impure wave, not a pure scalar wave, and that is not what we wish.

A better way is to bend or curve spacetime itself in a small region, so that a longitudinal wave that passes through that region now possesses a vertical component with respect to that region (Figure 6). Thus a normal detector there will detect that vertical component. We conduct the detection current out of the "bent spacetime" region to an outside (normal) detector, and we then have a scalar wave detector.

To illustrate, we show conceptually how this has been successfully done. Figure 7 shows the concept. First, we utilize a magnetic pole to provide the infolded energy (potential) to bend or curve spacetime. To reach good sensitivity, we need a pole strength connected with a magnetic field strength of 40,000 Gauss or higher. We utilize a small superconducting magnet, which can reach field

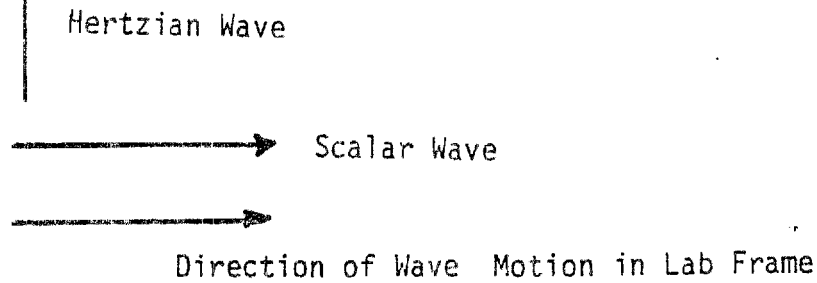

Figure 4. Linear, uncurved laboratory frame.

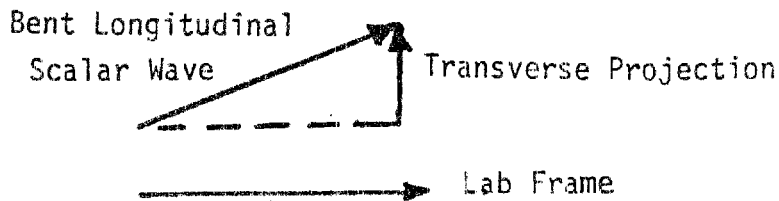

Figure 5. Rotating the longitudinal wave produces a transverse component.

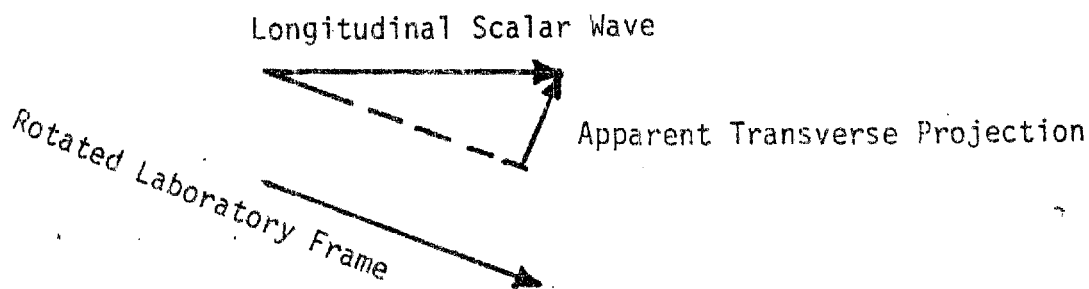

Figure 6. Bending the laboratory spacetime frame produces a transverse component.

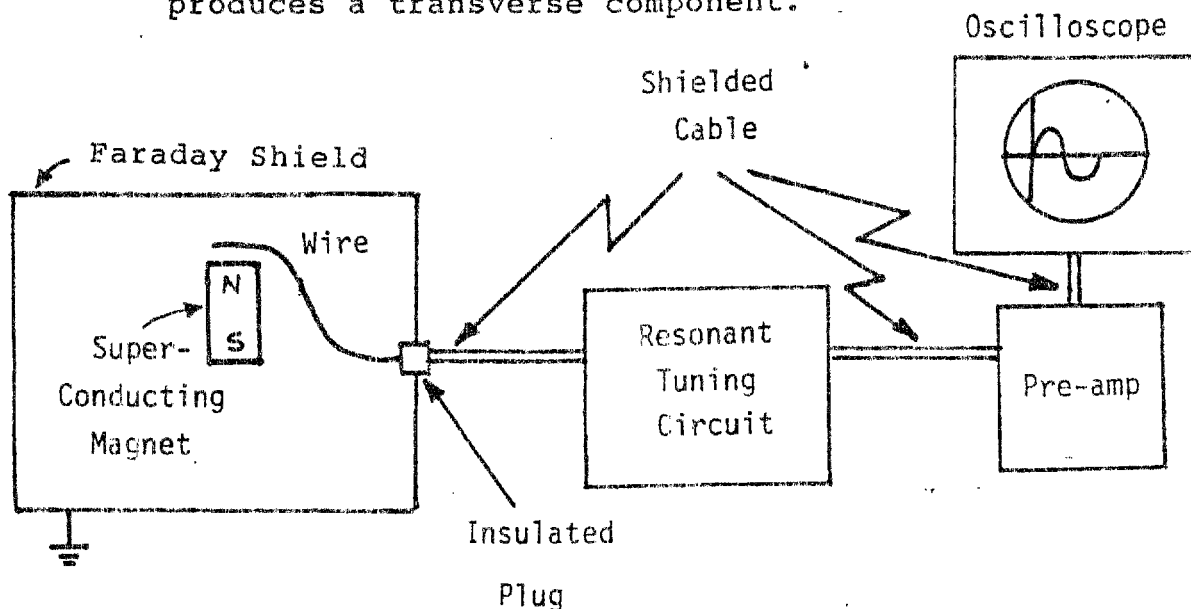

Figure 7. A sensitive scalar wave detector.

strengths of from 40,000 to 80,000 Gauss.

Then to prevent detection of superfluous "normal" radiation, we shield the entire magnet in a grounded Faraday cage, as shown in the figure. Hertzian waves will be grounded in this shield, while scalar waves will readily penetrate it undiminished. In other words, the Faraday cage serves as a "stripper," to strip away the ordinary waves, leaving only the scalar waves to penetrate inside. An ordinary wire lies at the top of the magnetic pole, in proximity to it. The wire runs out of the Faraday cage through an insulated port to a resonant tuning circuit, which is sharply tunable over the range of frequencies we are interested in. A preamp amplifies the output of the tuner, and in turn feeds the input of an oscilloscope or other detector.

With this detector we can select the frequency desired, and detect any passing scalar waves of that frequency. By other variations of amps and preamps, regenerative circuits, etc. we can obtain all the sensitivity desired, and utilize ordinary detection equipment already well-known and highly developed.

- Scalar Interferometry and Weaponization -

According to the Bohm-Aharonov effect, if two zero-field scalar wave beams are crossed in a distant region, real physical effects exist in that distant interference zone. In short, one may create "transmitting scalar interferometers" (Figure 2) to produce energetic effects at a distance, in a specified region. For a theoretically perfect scalar interferometer, all the energy fed into the remote transmitters is exhibited in the effects experienced in the interference zone, without "traveling through the space in between."

This can be comprehended by realizing that energy at the transmitter sites is transformed into stress-energy of vacuum (i.e., pure potential), and it is the potential variation that is accomplished, not transmission of energy through space per se.

We stress that locked-in or infolded vacuum energy in a potential and vector energy in transition are two quite different aspects of the same thing, just as energy and mass are two different aspects of one thing. In the interference zone of two intersecting scalar beams, the out-of-phase regions no longer have sum-zeroed substructure components, so E and B fields appear there, created by the now out-of-phase substructure superpositions. If other E and B fields are already there, these new fields superpose with them, either constructively or destructively. If they add, the existing fields are augmented and increased. If they oppose, the existing fields are diminished or negated. Thus the transmitting scalar interferometer can create or extinguish electromagnetic fields at a distance. In other words, it can produce energy in the distant target interference zone or extract energy from it.

Continuous input of energy at the transmitter sites

produces continuous emergence of energy at the remote interference site. A continuous-wave jammer using this mode, for example, will place all its transmitted power in a small volume around the targeted radar at a distance (Figure 8). The drastic increase in lethality of the jammer is obvious; there is no square-law loss, but only a volumetric dilution around the target itself. Indeed, this type of jamming can be applied to disable and destroy electromagnetic circuits of all types, in widely varying equipments such as tanks, aircraft, communications centers, vehicles, command posts, etc. It is also quite lethal against human beings. Of course a ground radar can be utilized in a scalar interferometer mode and fire back at the aerial attacker, as shown in Figure 9.

If a highly energetic scalar pulse is synchronously transmitted by each of two remote transmitters, then in the distant interference zone where the two pulses intersect, an impulsive emergence of ordinary electromagnetic energy occurs. This can produce an electromagnetic explosion at the distant intersection site, with concomitant electromagnetic pulse being radiated, etc. Even in the hard vacuum of space, such an electrical explosion and EMP are produced, since the electromagnetic energy produced in the interference zone is sufficient to lift Dirac electrons and other Dirac matter from the Dirac sea, producing a plasma very similar to a nuclear explosion, except for the absence of gamma radiation and nuclear residues. Evidence of Soviet weaponization of such effects is widespread in the open-source literature. [g]

Again, the lethality of the jammer/transmitter is vastly expanded by such adaptation. Indeed, jammer/transmitters using scalar interferometer techniques are capable of attacking most military targets, such as tanks, aircraft, vehicles, installations, fuel dumps, ammunition dumps, inflammable supplies, personnel, etc. The jammer/transmitter itself becomes a totally new kind of directed energy weapon having nearly ubiquitous military application.

These and other implications of scalar electromagnetics have already been pointed out by this researcher [h][i]. Examples of testing of scalar electromagnetics weapons are given in Appendix I.

If continuous energy is fed into the transmitters of the scalar interferometer, then continuous energy emerges in the distant interference zone. For very narrow beams and substantial input energy, the distant energy density can be made quite high. Physical destruction of distant targets can be accomplished in this fashion; and the effects can be produced directly inside bunkers, buildings, tanks and armored vehicles, aircraft, nuclear-tipped missiles, ships, etc.

Relativistic effects such as a change in the rate of flow of time, in the inertia of an object, and in the mass of an object can also be obtained, at least in theory. [j] In theory the speed of light in vacuo can also be changed, and there is already experimental evidence of this effect. [k]

Figure 9. GROUND-TO-AIR USE

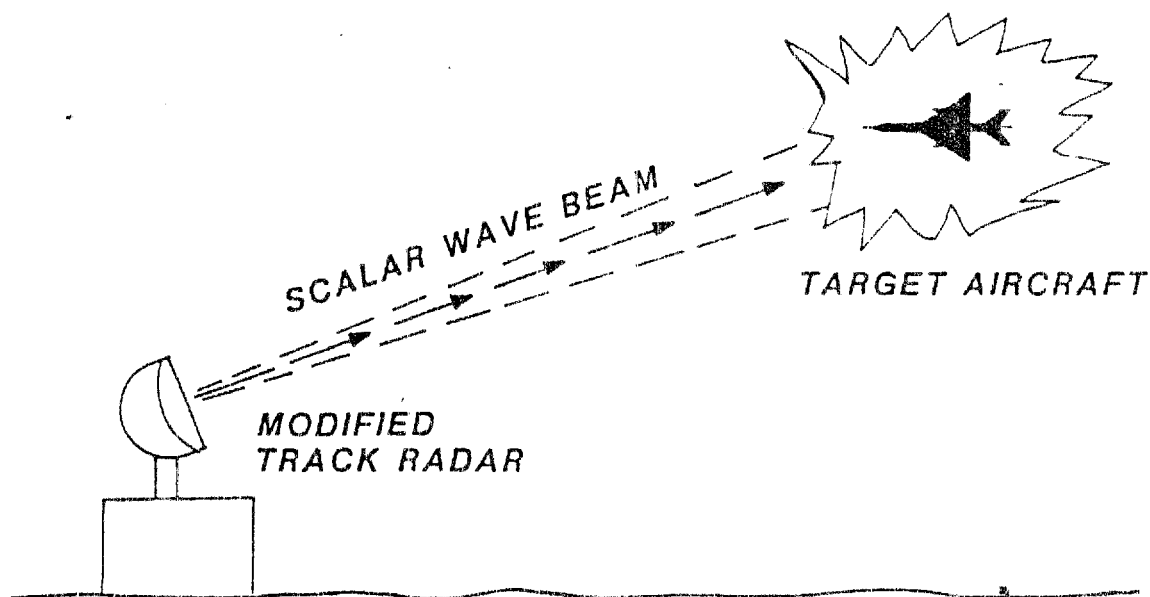
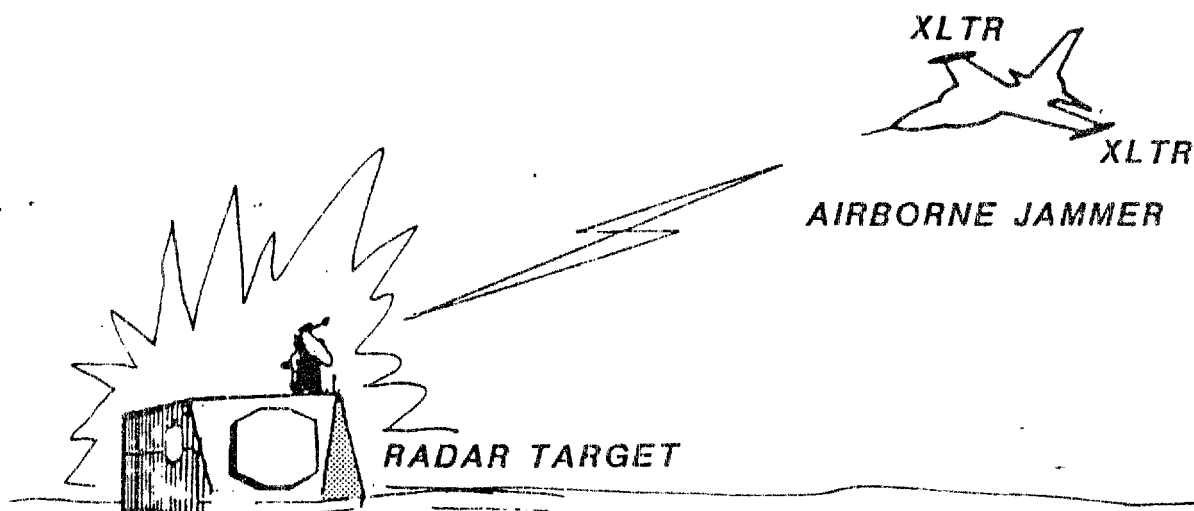

Figure 8. TACTICAL AIR-TO-GROUND USAGE*



- Vacuum Theory -

Since in the modern view the vacuum is composed of massless charge, it can be regarded as a single giant electrostatic scalar potential and magnetostatic scalar potential combined, with zero E and H fields. If one were developing weaponry based on the new scalar electromagnetics, then one might expect to find an energetics theory dealing with such a vacuum and based on scalar concepts. One might even utilize a type of field theory based on a fundamental particle conceptualized as a "little piece of vacuum medium". Indeed, evidence for just such a theory exists in the Soviet literature [l], and direct evidence of the Soviet view of the importance of such a concept was certainly provided by the Petukov-Toth affair. [m]

-Extraction of Distant Energy: A New Concept -

A second highly strategic implication of scalar electromagnetics is that a scalar interferometer connection between transmitter sites and a distant interference zone can be viewed somewhat as a sort of "electrical ground wire" or "common potential" connection between the projectors and the interference site. That is, it represents a "zero-field" connection between them. By establishing a resonance between the distant site and the projector sites, randomized field zeroing that occurs in the natural temperature oscillations at the distant site can be utilized to extract energy from the site to the projectors. That is, one may extract electromagnetic energy from a distance target or region, as well as produce energy at a distance. Again, the energy extracted is not transported through space as normal electromagnetic energy, but as pure scalar potential.

The mechanism for this may easily be seen if one recognizes that, when fields zero by opposition, the vectors comprising the opposition at that point also comprise a special value of scalar potential. Since each single field vector in the opposition has energy, then the energies of the opposing vectors are "locked-in" as spatiotemporal stress of the scalar potential at that opposition point. Thus "ordinary energy" has been converted to "stress of spacetime" (scalar potential). That POTENTIAL, which is simply massless charge, can then directly affect a distant system [a] and can even do it instantaneously. [f]

Thus the scalar potential can be used, by interferometry, to directly produce energy in a distant target or extract energy directly from that target.

Indeed, because of this hitherto unknown effect, the present conservation of energy law is but a special case of a more fundamental stress conservation law. This more fundamental stress conservation law has already been derived by this researcher. [i, pp. 10-11, 43] See Table 1 for a synopsis.

MUSHROOM CLOUD FROM SEA OFF JAPAN NEAR RUSSIAN TEST AREA

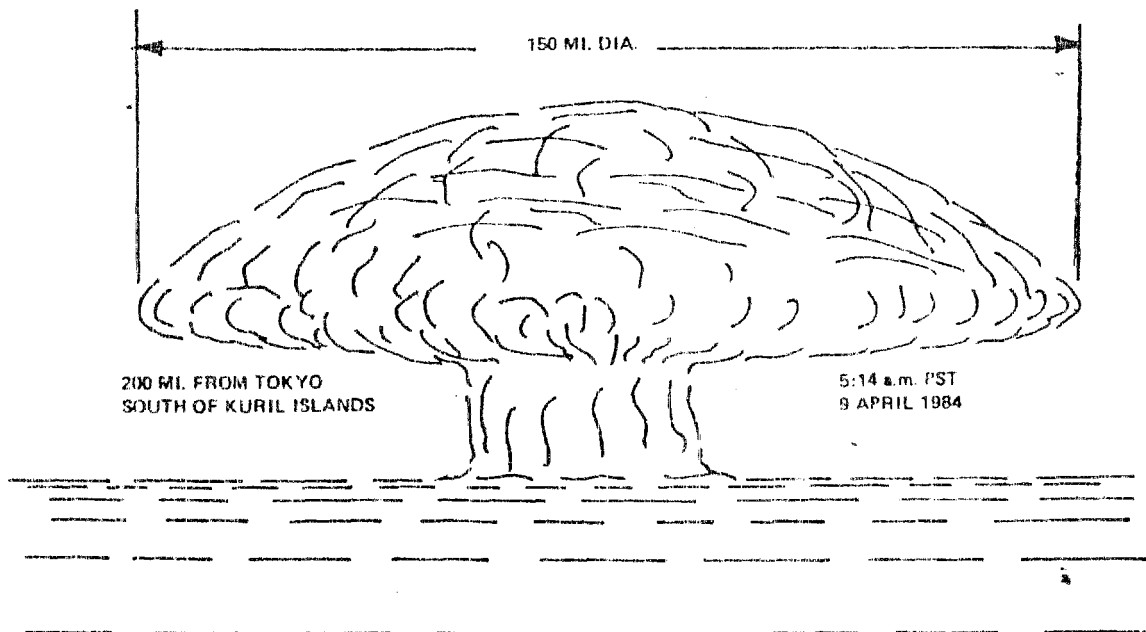

Table 2. **MUSHROOM CLOUD RISING FROM SEA**

- 0514 HRS, 9 APRIL 1984
- GRAY-WHITE CLOUD APPEARED
- ROSE 60,000 FT IN 2 MIN.
- 180 MI. S.E. OF HOKKAIDO
200 MI. FROM TOKYO
SOUTH OF KURIL ISLANDS
- SOVIET MISSILE TESTING SCHEDULED ABOUT 350 MI.
AWAY, AT 2100 HRS 9 APR 1984

Table 3. **MUSHROOM CLOUD FROM SEA OFF JAPAN**

- **FIVE BOEING 747'S FLEW THROUGH OR NEAR THE CLOUD**
 - **NO CONTAMINATION**
 - **NON-NUCLEAR**
- **OCEAN 21,000 FT DEEP**
 - **TOO DEEP FOR SUBMARINE VOLCANO TO CAUSE CLOUD**
 - **INDICATES MAN-MADE PHENOMENON**
- **77 OTHER SUCH PLUMES SINCE 1974**
 - **IN SOVIET ARCTIC**
 - **IN NON-VOLCANIC AREA**
 - **NON-NUCLEAR**

Table 4. **PLUMES NOTED IN SATELLITE PHOTOS IN
SOVIET ARCTIC (77 SINCE 1974)**

- **2 AIRCRAFT FLEW THROUGH FOR ANALYSIS**
 - **SOLID MATERIAL**
 - **MOSTLY ICE**
 - **A LITTLE CLAY**
 - **MUCH COLDER THAN SURROUNDING AIR**
 - **NO VOLCANIC MATERIAL**
 - **NO RADIOACTIVE MATERIAL**
- **MAY BE 2 TO 3 TIMES AS MANY INCIDENTS**
 - **ONLY EXAMINED SATELLITE IMAGERY IN WINTER**
 - **ONLY PERIODIC SATELLITE COVERAGE**
 - **HYPOTHESIZE METHANE VENTING**
 - **HYPOTHESIZE SOVIET CLOUD SEEDING**

- Massive Testing of "Cold Explosions" -

Direct evidence for a decade of massive Soviet testing of such "energy extraction" strategic systems has recently become apparent. [n, p. 8] Since 1974, very large, anomalous mushroom-shaped ice cloud formations have been repeatedly produced over the Soviet Arctic and detected by U.S. weather satellites. These formations arise suddenly and are very much colder than the surrounding air. They appear to be the result of firing a large scalar interferometer in an "energy extraction" mode; in other words, a "cold explosion" occurs at the distant interference site.

Recently a most dramatic example of such a cold explosion occurred near a pre-announced Soviet weapons test zone off Japan. [n] (See Figure 10 and Tables 2, 3, 4). The mushroom cloud reached 60,000 feet altitude in about 2 minutes, and had a diameter of 150 miles. Several Boeing 747s were in the area, and were later checked for radioactivity with negative results.

In fact, the U.S. has detected at least 78 such Soviet tests [n, p. 8] since 1974, with far less than continuous satellite coverage and little more than cursory imagery examination. Two or three times as many such Soviet "cold explosion" tests may actually have occurred. The direct implication for worldwide weather engineering by the Soviet Union is obvious.

Note also that a "cold explosion" of over 150 miles diameter represents an interference zone of about the size of the heart of the main troop deployments in the NATO Central Region. A single shot of such a weapon could almost instantly freeze every NATO soldier in that area into a block of ice. Note also that the heat energy is extracted throughout the spacetime of the area; insulation or external heat sources are no defense. The heat literally is "sucked out" of the interior of bodies in the interference zone. Several such "cold explosion" shots could finish off the entire NATO central region -- again, in seconds or minutes. And since the Soviets would have given NATO no nuclear provocation, it is doubtful that a U.S. President would launch a strategic nuclear attack against the Soviet Union in such an eventuality. Particularly if monstrous "cold explosions" appeared without warning in densely populated regions of the U.S. In fact, one may argue that the Western military and civilian leaders would not even grasp what was being done to them, or who was doing it!

Of course the same scalar interferometer can be used in the "produce energy" mode, in which case it can jam or knock out almost all electronic equipment in the target zone, detonate explosive materials therein, etc. Note that a massive electrical fireball -- say several megatons -- over New York City would give all the "desirable" effects of a nuclear weapon, without any of the "undesirable" effects. It would give the thermal radiation, the blast wave, and the EMP effects, but would not give the gamma radiation and nuclear fallout. So it would burn up and blow down things, kill people, and knock out electrical systems, but would not

contaminate the area. This, of course, would be very important to the Soviets if they wished to salvage the Western farmland without nuclear contamination.

- The Perfect Missile Shield -

By utilizing three-dimensional truncated Fourier expansion techniques with multiple transmitted frequencies, the scalar interferometer beams can be made to interfere in specific geometric patterns, such as giant hemispheric shells of glowing energy, quite useful in a strategic ABM defense of a large area. Such tests of such giant ABM shields have actually been observed by competent witnesses. [o] Typical examples of a variety of tests of weapons using this mode are given in Appendix I.

- Massive Soviet Weaponization -

The Soviets have been engaged in weaponizing scalar electromagnetics for nearly three decades, as evidenced by Khrushchev's eerie 1960 announcement [p] of a fantastic weapon, more terrible and perfect than rockets and missiles. (See Table 5). In addition, such weapons may be what Brezhnev was referring to when the Soviet team at the SALT talks in 1975 introduced the strange proposal that we should also consider outlawing the development of new electromagnetic weapons of a most terrible nature -- more frightful than the mind of man had ever imagined. (See Table 6).

Scalar electromagnetic weapons are directly applicable to nearly all phases of warfare, both tactical and strategic, and both offensive and defensive. They can be used to accomplish nearly 100% ABM defense of very large areas and they can destroy ICBMs, TBMs, cruise missiles, aircraft, ordnance, tanks, weapons carriers, personnel carriers, submarines, SLBMs, surface ships, communications equipment, fuel supplies, ammunition supplies, nuclear warheads, and personnel with ease and efficiency. They can be made large or small -- indeed, one can be made as small as a large pistol, and carried in the hand. The "Buck Rogers" ray pistol is now a reality.

With such weapons vast areas can be completely destroyed or neutralized within minutes, without permanent contamination. These weapons can also be used to accomplish weather and climate control on a worldwide scale, as well as to cause earthquakes, and they have been already been employed in both modes by the Soviet Union.

- Soviet Weather Engineering -

Essentially, in the "produce energy" mode a powerful scalar interferometer can produce a large high pressure area or "hot spot" at a given distant target area. In the "extract energy" mode, a large low pressure area or "cold spot" can be produced at a given distant target area. Each of these spots can be moved by "sweeping" the interferometer

Table 5.

KHRUSHCHEV'S 1960 STATEMENT

(Speaking to the Presidium)

WE HAVE A NEW WEAPON,
JUST WITHIN THE PORTFOLIO OF
OUR SCIENTISTS . . .
SO POWERFUL THAT,
IF UNRESTRAINEDLY USED,
IT COULD WIPE OUT ALL
LIFE ON EARTH!

Table 6.

BREZHNEV'S 1975 PROPOSAL

AT THE SALT TALKS
ON JUNE 13, 1975:

THE SOVIETS URGED THE U.S.
TO AGREE ON A BAN OF
RESEARCH AND DEVELOPMENT

OF NEW KINDS OF WEAPONS

MORE TERRIBLE THAN
ANYTHING THE WORLD HAS KNOWN!

bears so as to change the location the distant interference zone. (That is, one synchronously rotates the interferometer beams so as to gradually change the location of the distant interference zone, which is creating the spot.) By using multiple transmitters and fairly broad beams, an interference grid can be created over an entire continent or substantial portions of it. (Figure 11). In each grid block in the interference zone, energy can be produced or extracted. (Figure 12). Direct evidence for such usage by the Soviets over North America has been presented. [q] Certain "signatures" of the Soviet weather control interferometry grid system have been observed all over the U.S. (Figures 13, 14, 15, 17, Table 7), and one major signature has been photographed over Huntsville, Alabama by this author. It is stressed that our normal instruments do not usually detect the directly active scalar beams, unless we detect longitudinal waves as shown in Figure 16. A more definitive paper on this overt weather engineering over North America is in preparation.

- Conclusion -

As can be seen, the new (to the West) scalar electromagnetics is a reality, as evidenced by the Bohm-Aharonov work and its direct experimental proof. The implications for weaponization on a massive strategic and tactical scale are obvious, and unfortunately the Soviet Union has already developed several generations of such weapons. At least one other country has also developed scalar electromagnetics weaponry.

The Soviet scalar electromagnetics weapons development program appears to have been well underway at the time of the beginning of the "microwave radiation" of the U.S. Embassy in Moscow, about 1959 or 1960. (Table 8). A good description of the history of this microwave radiation has been given by Brodeur from a normal electromagnetics viewpoint. [r] Note that "twin beams" were utilized in the radiation, at least from time to time, and a variety of systemological difficulties were induced in personnel in the Embassy. As late as 1982, major Soviet representatives continued to announce warnings of the impending use of new Soviet weapons more powerful than nuclear arsenals. (Table 9). A variety of other potential incidents of overt Soviet use of scalar wave weapons against the U.S. has been presented by this author. [s][t]. Typical examples are given in Appendix I.

To repeat, evidence of massive Soviet testing of scalar electromagnetics weapons on a global scale abounds in the open literature. The Soviets have been deploying and repeatedly testing these weapons for nearly three decades, without being recognized by the Western intelligence and scientific communities for what they were.

The West is almost totally defenseless against these frightful Soviet scalar electromagnetics weapons, and an immediate "Manhattan Project" to develop defenses on a crash basis is urgently needed if we are to survive at all.

Figure 11. NETWORK OF VIRTUAL TRANSMITTERS

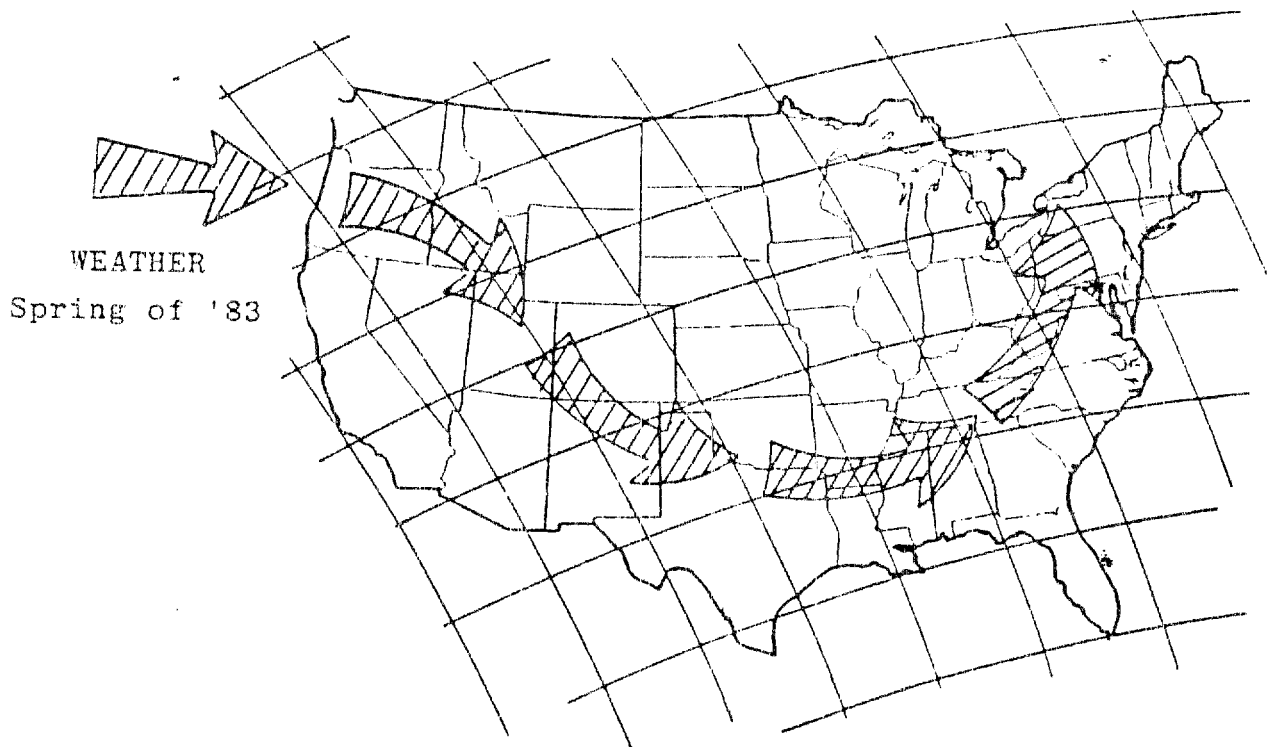

Figure 12. VIRTUAL TRANSMITTERS IN THE INTERFERENCE GRID

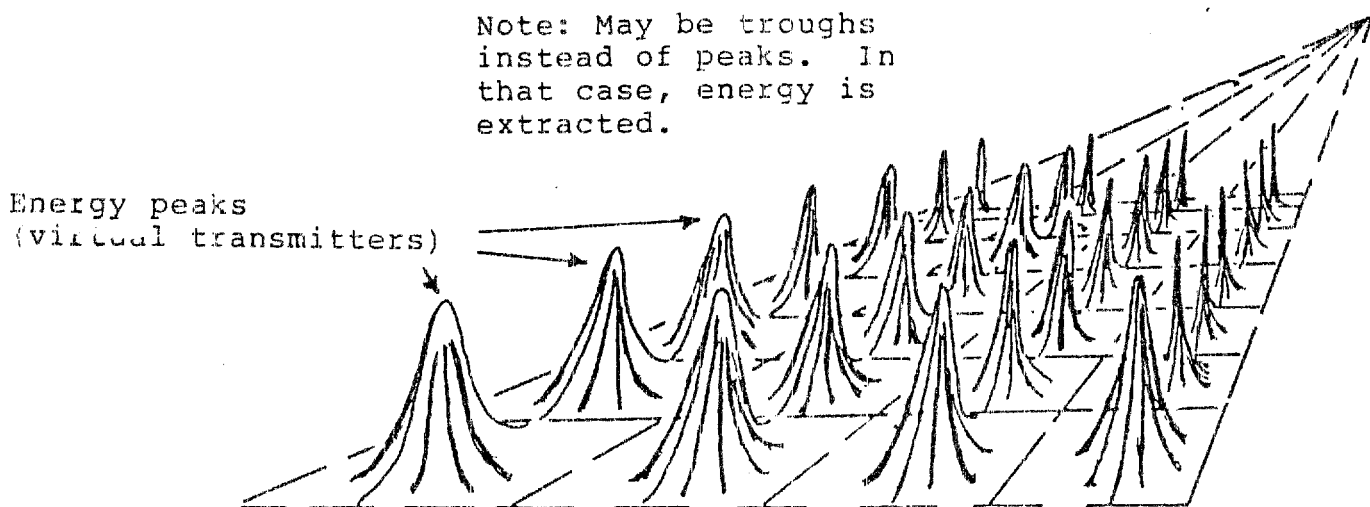

Figure 13. GIANT RADIAL RELATED TO A VIRTUAL TRANSMITTER

Fall 1983:
Florida,
Alabama,

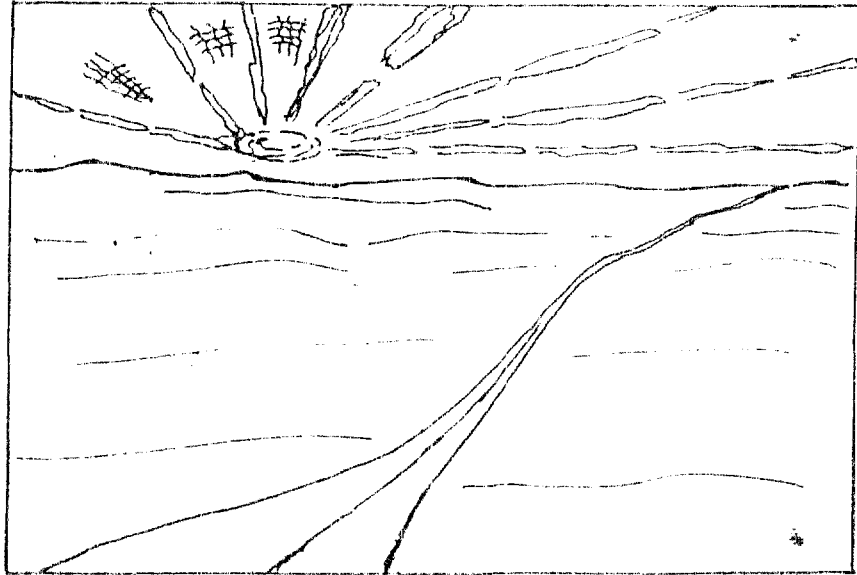
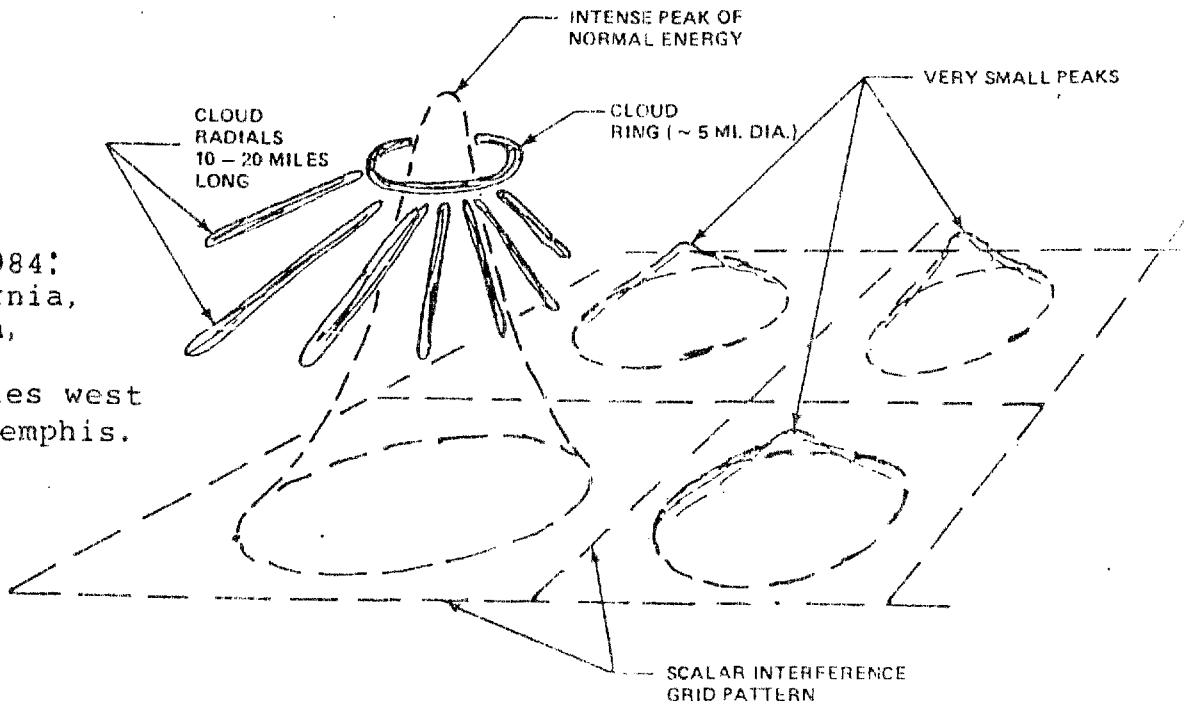

Figure 14. FORMATION OF A SINGLE GIANT RADIAL

Early 1984:
California,
Alabama,
Iowa,
400 miles west
of Memphis.



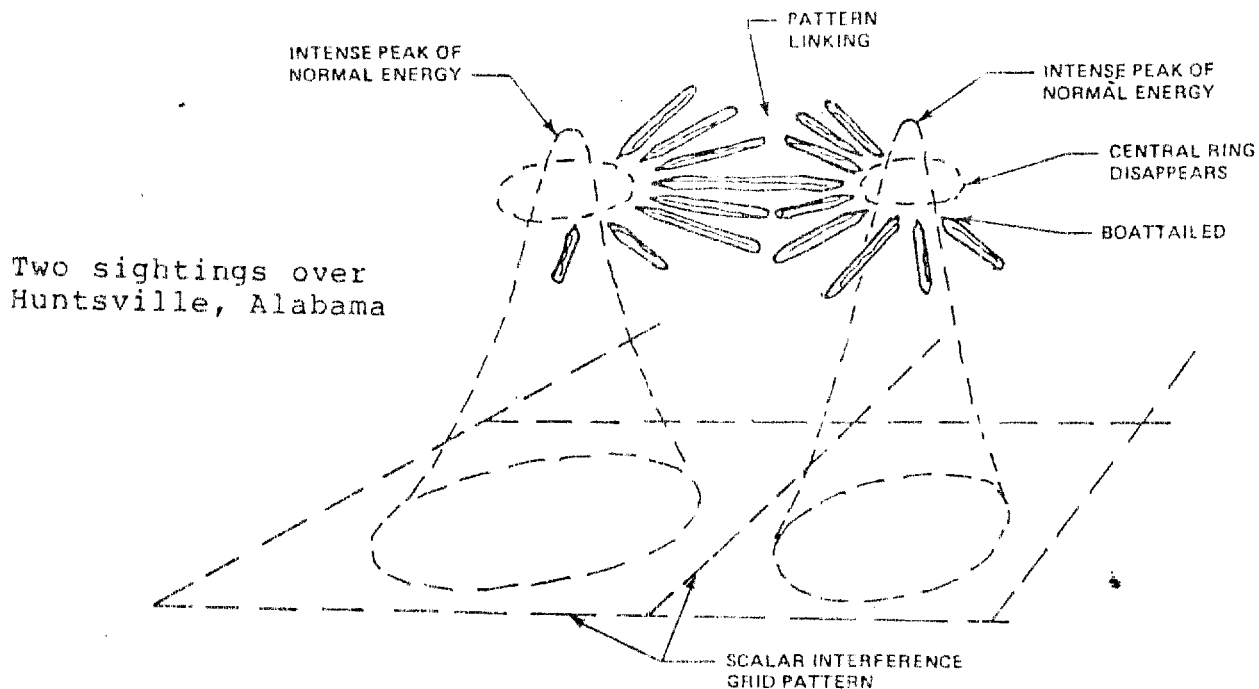

Figure 16. **DETECTION OF TRANSVERSE AND LONGITUDINAL WAVES**

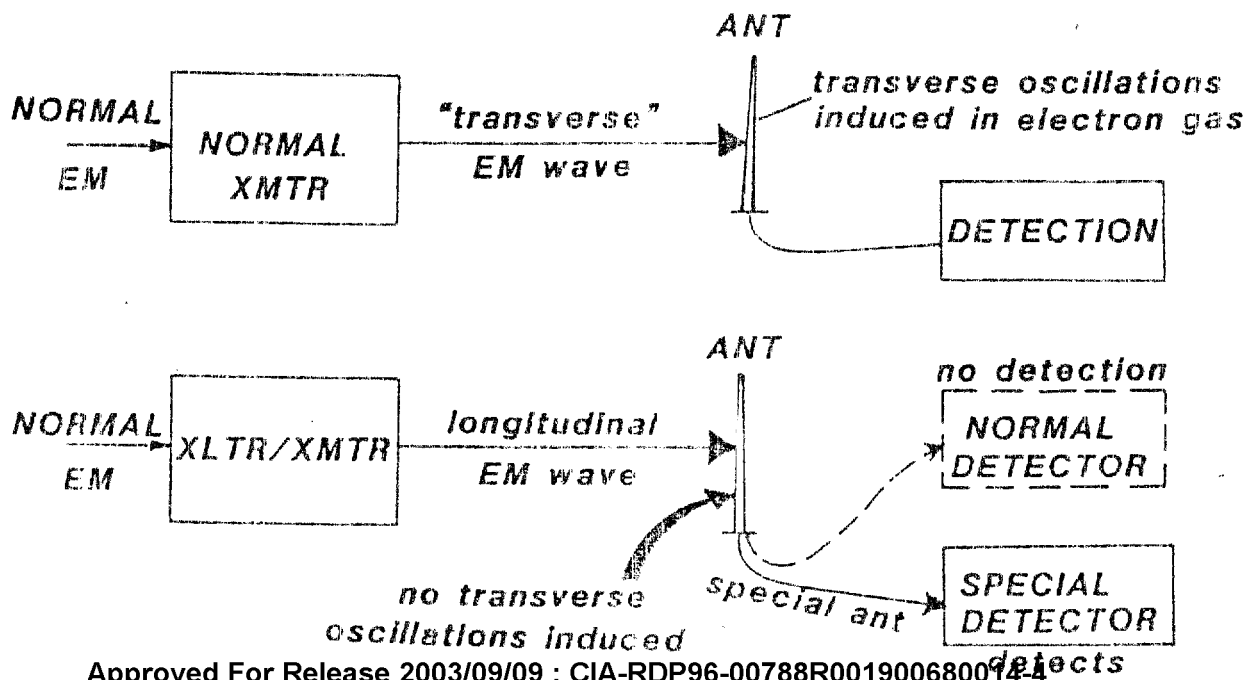

Figure 17. **TWIN GIANT RADIAL PATTERN**

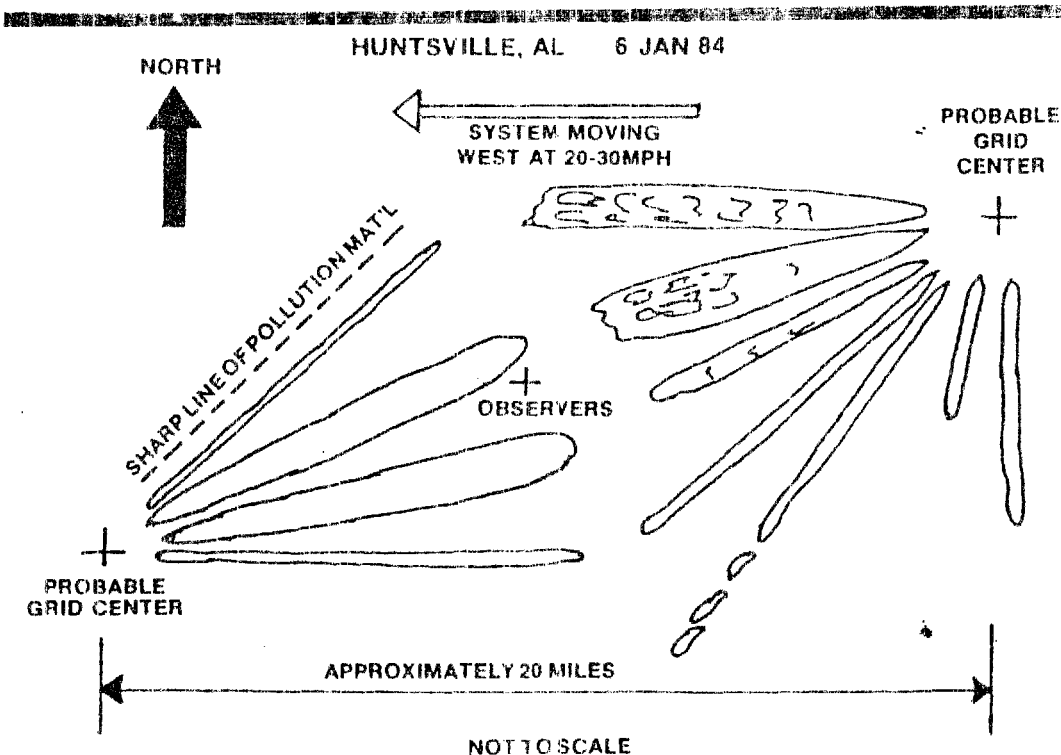

Table 7. **TWIN GIANT RADIALS**

- FRIDAY, 6 JAN 84, 0700-0745
- REDSTONE ARSENAL, ALABAMA
- MULTIPLE OBSERVERS
- WEATHER CLEAR EXCEPT FOR THIS SYSTEM
- EXTREMELY GOOD VISIBILITY
- SYSTEM MOVING WEST ~ 20-30 MPH
- REMNANTS OF A SECOND TWIN GIANT RADIAL SYSTEM SEEN IN SAME AREA 1130-1145 HRS

RADIATION OF THE U.S. EMBASSY IN MOSCOW

- SINCE 1959 OR 1960
- HIGH LEVEL TARGET (U.S. AMBASSADOR)
- GUARANTEES PERSONAL ATTENTION OF
 - PRESIDENT
 - NSA, CIA, DIA
 - TOP CONSULTING SCIENTISTS
 - STATE DEPARTMENT
 - LEADING SCIENTIFIC INSTITUTIONS
 - NATIONAL SECURITY COUNCIL
 - ETC.
- REACTION REVEALS U.S. KNOWLEDGE OF TESLA ELECTROMAGNETICS
- FOUR U.S. PRESIDENTS REQUESTED SOVIETS TO CEASE
 - CUT FROM 18 μ WATTS/CM² TO 2
 - THEN AGAIN INCREASED

Table 9. **LYSENKO'S 1982 STATEMENT**

WORLD FUTURES CONFERENCE
WASHINGTON, D. C.
20 JULY 1982

- LYSENKO (FIRST NAME UNK)
- USSR REP (SOVIET EMBASSY, WASHINGTON, D.C.)
- STATED WILL SHORTLY SEE DEVELOPMENT OF NEW WEAPONS
 - MORE POWERFUL THAN NUCLEAR WEAPONS
 - WILL BE NONVERIFIABLE

REFERENCES

- a. Y. Aharonov and D. Bohm, "Significance of Electromagnetic Potentials in the Quantum Theory," Phys. Rev., Second Series, Vol. 115, No. 3, August 1, 1959, pp. 485-491.
- b. R. G. Chambers, Phys. Rev. Lett., Vol. 5, 1960, p. 3.
- c. Tai Tsun Wu and Chen Ning Yang, "Concept of nonintegrable phase factors and global formulation of gauge fields," Phys. Rev. D, Vol. 12, No. 12, 15 December 1975, pp. 3845-3857.
- d. Richard P. Feynman, Robert B. Leighton, and Matthew Sands, The Feynman Lectures on Physics, Volume II, Section 15-5, pp. 15-8 to 15-14.
- e. E. T. Whittaker, "On an Expression of the Electromagnetic Field Due to Electrons by Means of Two Scalar Potential Functions," Proc. Lond. Math. Soc., Vol. 1, 1903, pp. 367-372.
- f. John David Jackson, Classical Electrodynamics, Second Edition, Wiley, New York, 1975, p. 223.
- g. "Scientists Fail to Solve Vela Mystery," Science, Vol. 207, 1 February 1980, pp. 504-506. "Satellite Evidence Shows 'Possibility' of Nuclear Test, DOD Says," Aerospace Daily, October 29, 1979, p. 286. "A Flash of Light," Newsweek, November 5, 1979, pp. 64-65. "Was It a Nuclear Device?," Newsweek, July 21, 1980, p. 19. "Diverging Views," Washington Roundup, Aviation Week & Space Technology, July 21, 1980, p. 15. Philip J. Klass, "Clandestine Nuclear Test Doubted," Aviation Week & Space Technology, August 11, 1980, pp. 67, 69, 71-72. "Debate Continues on the Bomb That Wasn't," Science, Vol. 209, 1 August 1980, pp. 572-573. "Navy Lab Concludes the Vela Saw a Bomb," Science, Vol. 209, 29 August, 1980, pp. 996-997.
- h. T. E. Bearden, "Toward a New Electromagnetics: Part III: Clarifying the Vector Concept," Tesla Book Co., 1580 Magnolia, Millbrae, CA 94030, 1983.
- i. T. E. Bearden, "Toward a New Electromagnetics: Part IV: Vectors and Mechanisms Clarified," Tesla Book Co., Millbrae, CA, 1983.
- j. Ingram Bloch & Horace Crater, "Lorentz-invariant potentials and the non-relativistic limit," Am. J. Phys., Vol. 49, No. 1, January 1981, pp. 67-75.
- k. B. N. Belyaev, "On Random Fluctuations of the Velocity of Light in Vacuum," Azvestiya Vysshikh Uchebnykh Zavedenii, Fizika, No. 11, Nov. 1980, pp. 37-42.

l. A. K. Lapkovskii, "Relativistic Kinematic Equations and the Theory of Continuous Media," Soviet Physics Journal, Vol. 21, No. 6, June-1978.

m. Martin Ebon, "Moscow, June 11, 1977," in his Psychic Warfare: Threat or Illusion, McGraw-Hill Book Co., New York, NY, 1983, pp. 1-11.

n. Greg Rippee, "Mushroom cloud sighted off Japan," Los Angeles Daily News, 11 April 1984, pp. 1, 8.

o. Gwynne Roberts, "Witness to a Super Weapon?," The Sunday Times, London, England, 17 August 1980.

p. Max Frankel, "Khrushchev Says Soviet Will Cut Forces a Third; Sees 'Fantastic' Weapon," New York Times, 15 January 1960, p. 1.

q. T. E. Bearden, "Soviet Weather Engineering," presentation on Open Mind Show, Radio Station KABC, Los Angeles, California March 24, 1984. (Audiotape available from Radio Station KABC, 3321 South LaCienega Blvd., Los Angeles, CA 90016.) Also T. E. Bearden, "Soviet Weather Engineering Over North America," in preparation. (To be presented at the U.S. Psychotronics Association Annual Symposium, Oglethorpe College, Atlanta, GA in June 1984.)

r. Paul Brodeur, The Zapping of America, W. W. Norton & Co., New York, 1977.

s. T. E. Bearden, "Solutions to Tesla's Secrets and the Soviet Tesla Weapons," Tesla Book Co., 1580 Magnolia, Millbrae, CA 94030, 1981.

t. T. E. Bearden, videotape, "Tesla's Secret and the Soviet Tesla Weapons," presented in absentia at the First International Unorthodox Energy Symposium, Toronto, Canada, 1981. Available from Tesla Book Co., Millbrae, CA.

APPENDIX I: TYPICAL INCIDENTS AND RELATED INFORMATION

<u>Item</u>	<u>Title</u>	<u>page</u>
1.	Tesla Weapon at Saryshagan (Scalar Potential Interferometer)	27
2.	"Nuclear" Flashes off the Coast of Africa	27
3.	Yugoslavian Earthquake	28
4.	Quake in Tangshan, China	28
5.	Giant ABM Shield Seen from Afghanistan	29
6.	Tesla Shield	29
7.	Continuous Tesla Fireball	30
8.	Mysterious Light over North Pacific	30
9.	Continuous Tesla EMP Globe	31
10.	Tesla ABM Defenses	31
11.	Hemisphere and Globes	32
12.	East Coast Aerial Blasts (High Burst Registrations?)	33
13.	Booms in Delaware	33
14.	1969 Virgin Islands Incident	34
15.	Expanding Dome-Like Phenomenon	35
16.	Two Arcs in the Sky	35
17.	"Laser" Blinding of U.S. Satellites	36
18.	Extreme Intensity Sky Brightening	36
19.	Radar Invisibility	37
20.	Creating an Inertial Field (Antigravity)	37
21.	Lightning Wall	38
22.	Anomalous Burns and Underwater Sounds	38
23.	"Cloud Arc"	39
24.	Needed: Immediate Crash Program	39

Item 1.

TESLA WEAPON AT SARYSHAGAN (SCALAR POTENTIAL INTERFEROMETER)

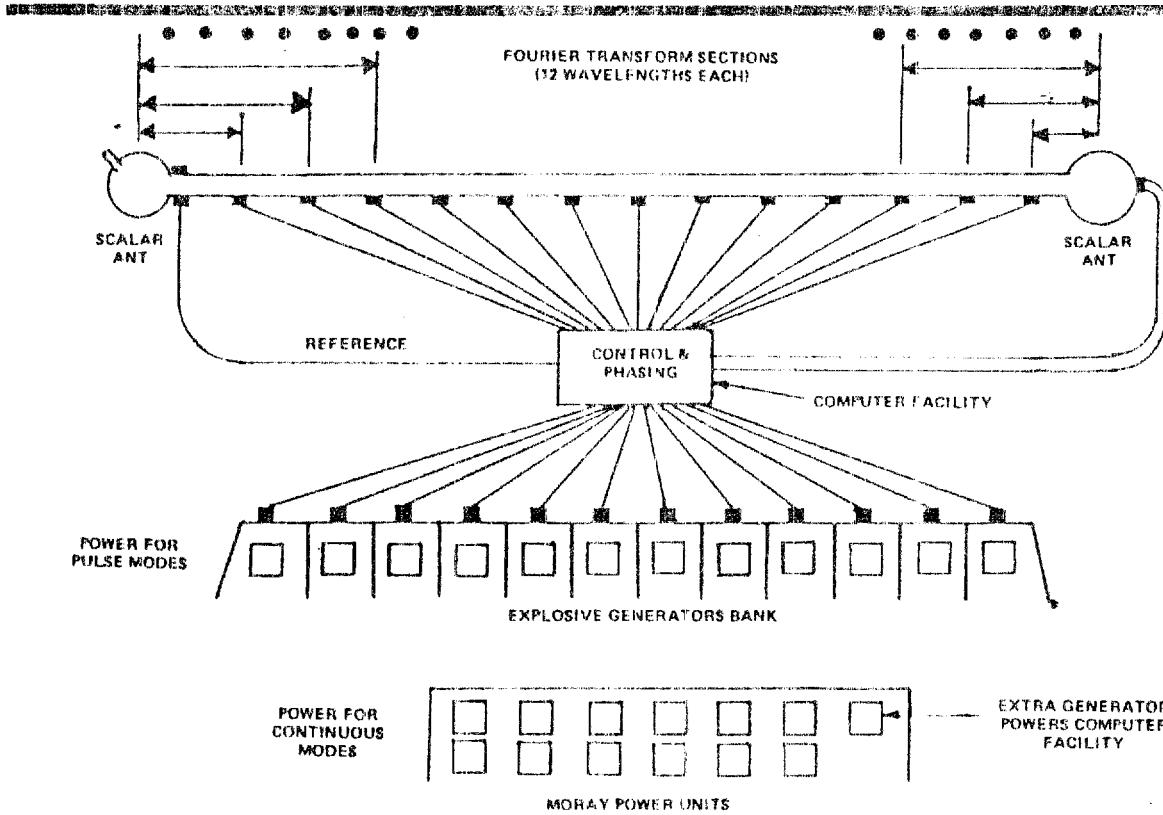

Item 2. "NUCLEAR" FLASHES OFF THE COAST OF AFRICA

Booms off U.S. east coast.

Flashes over Atlantic, off southwest coast of Africa, detected by Vela satellites.

Many other test incidents.

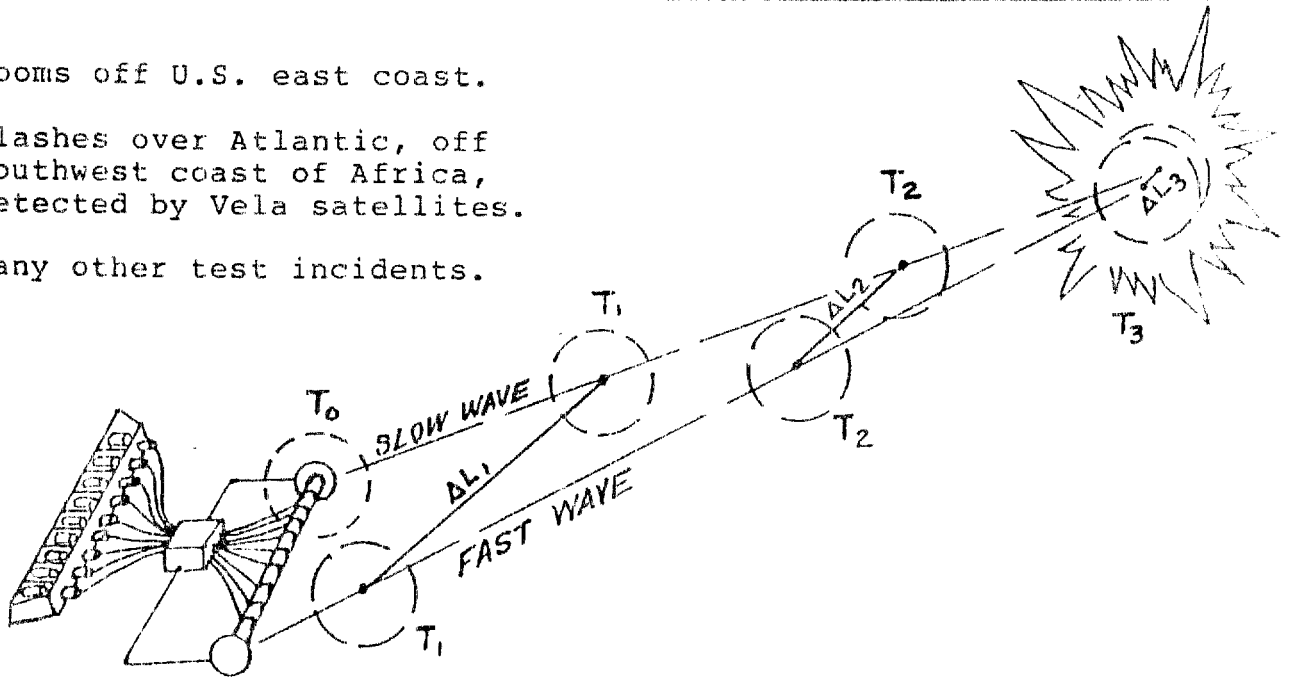

TESLA HOWITZER (SCALAR INTERFEROMETER)

Deep
Within
Soviet
Union

Toward
Saryshagan
Missile
Test
Range



Note close
proximity
in time to
first
"flash"
detected
by Vela
satellites

Nick Downie describes the strange lurid glow
that flared silently over the Hindu Kush.

The Sunday Times, London, 17 August 1980

Multiple incidents in September 1979.

Item 6.

TESLA SHIELD

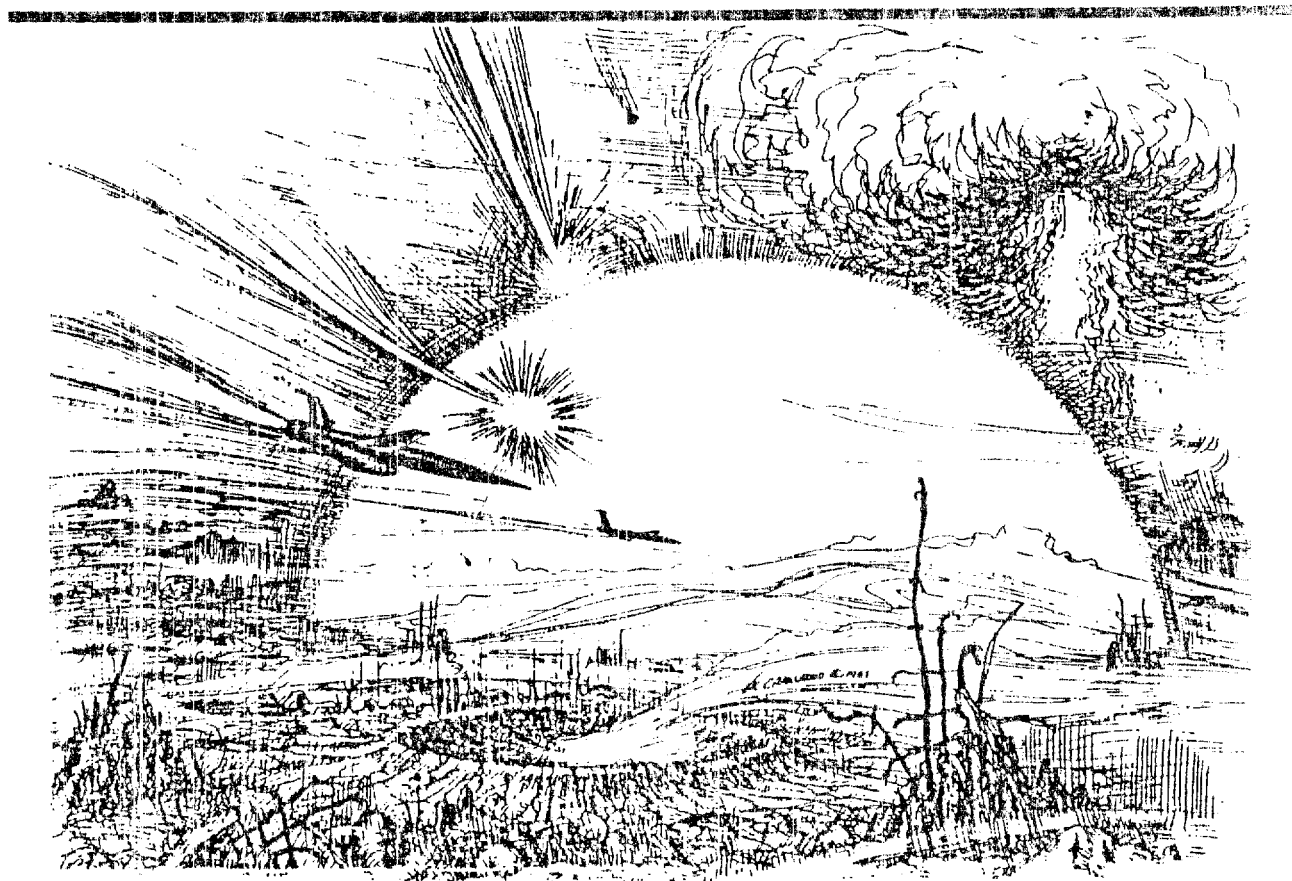

Courtesy Hal Crawford.

Item 3.

YUGOSLAVIAN EARTHQUAKE (TEST OF A TESLA HOWITZER ?)

- YUGOSLAVIAN EARTHQUAKE 15 APRIL 1979
- 7.2 ON RICHTER SCALE
- EPICENTER 33 km DEEP
- MORE THAN 100 AFTERSHOCKS
- AT KAMENARI:
 - ADRIATIC SEA MUSHROOMED UP
 - LIKE ATOMIC BOMB EXPLOSION
- ADDITIONAL DETAILS NEEDED

Item 4.

QUAKE IN TANGSHAN, CHINA

28 JULY 1976

- 7.8 ON RICHTER SCALE
- HUNDREDS OF THOUSANDS KILLED
- ACCOMPANIED BY LIGHT, ELECTRICAL EFFECTS
 - 3 TO 5 DAYS BEFORE
 - COMMUNICATIONS INTERFERENCE WITHIN 250 km
 - SKY LIGHTING OBSERVED

CONTINUOUS TESSA FIREBALL

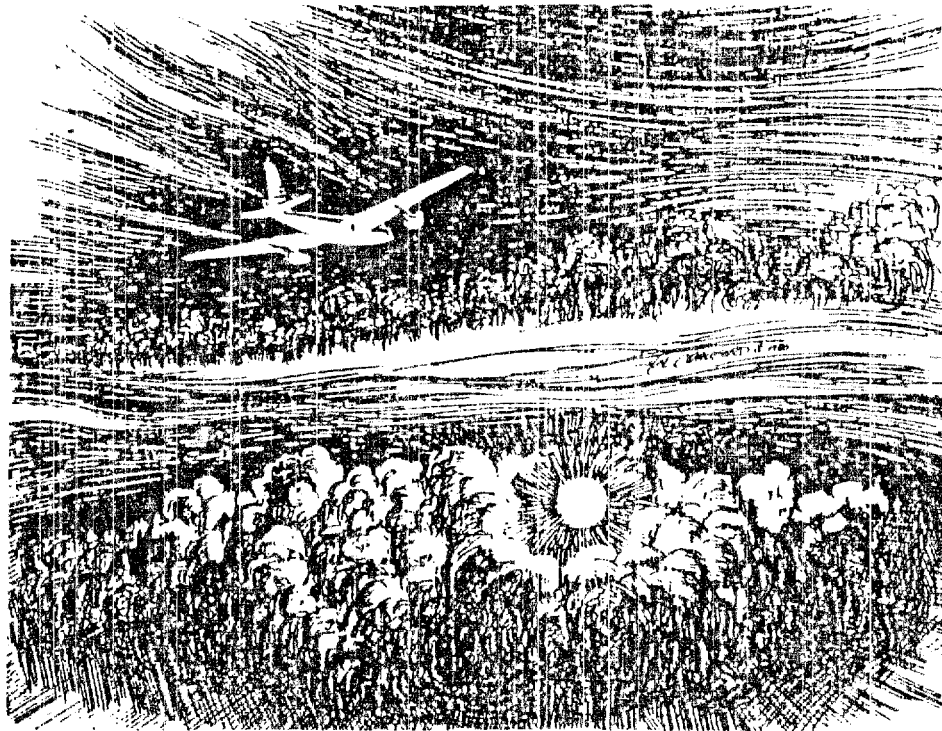

LITHUANIA
10 SEP 1976

BRITISH
EUROPEAN
AIRWAYS
FLIGHT # 831
BETWEEN
MOSCOW AND
LONDON

Courtesy Hal Crawford.

CIA REPORT RELEASED UNDER FOIA

Item 8. **MYSTERIOUS LIGHT OVER NORTH PACIFIC**

ASAHI EVENING NEWS
TOKYO
JUNE 22, 1982

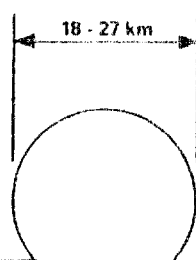

- JUNE 18, 1982
- NORTH PACIFIC
- 700 km EAST OF KUSHIRO
- JAL FLIGHT 403
- JAL FLIGHT 421

Continuous
Tesla EMP
globe and
giant ABM
shield.

SEEN FROM 42° N LAT
163° E LONG

CONTINUOUS TESLA EMP GLOBE

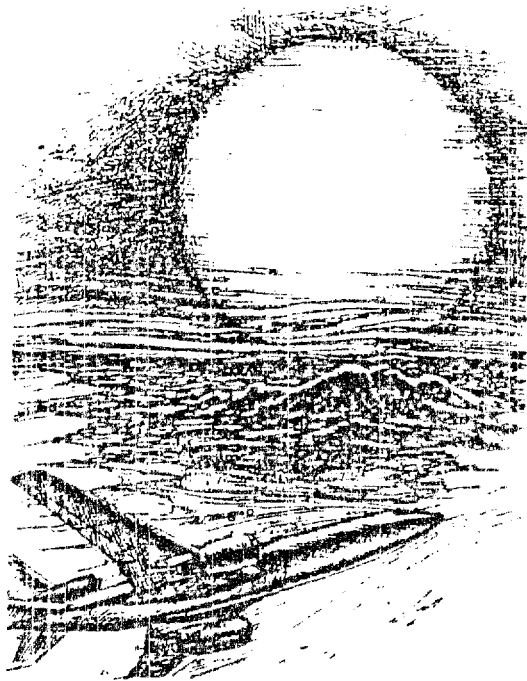

TEHERAN, IRAN 17 JUNE 1966

SEEN FROM NEAR MEHRABAD AIRPORT

OBSERVED 4-5 MINUTES

SEEN BY 2 AIRCRAFT

CIA REPORT RELEASED UNDER FOIA

Item 10. TESLA ABM DEFENSES

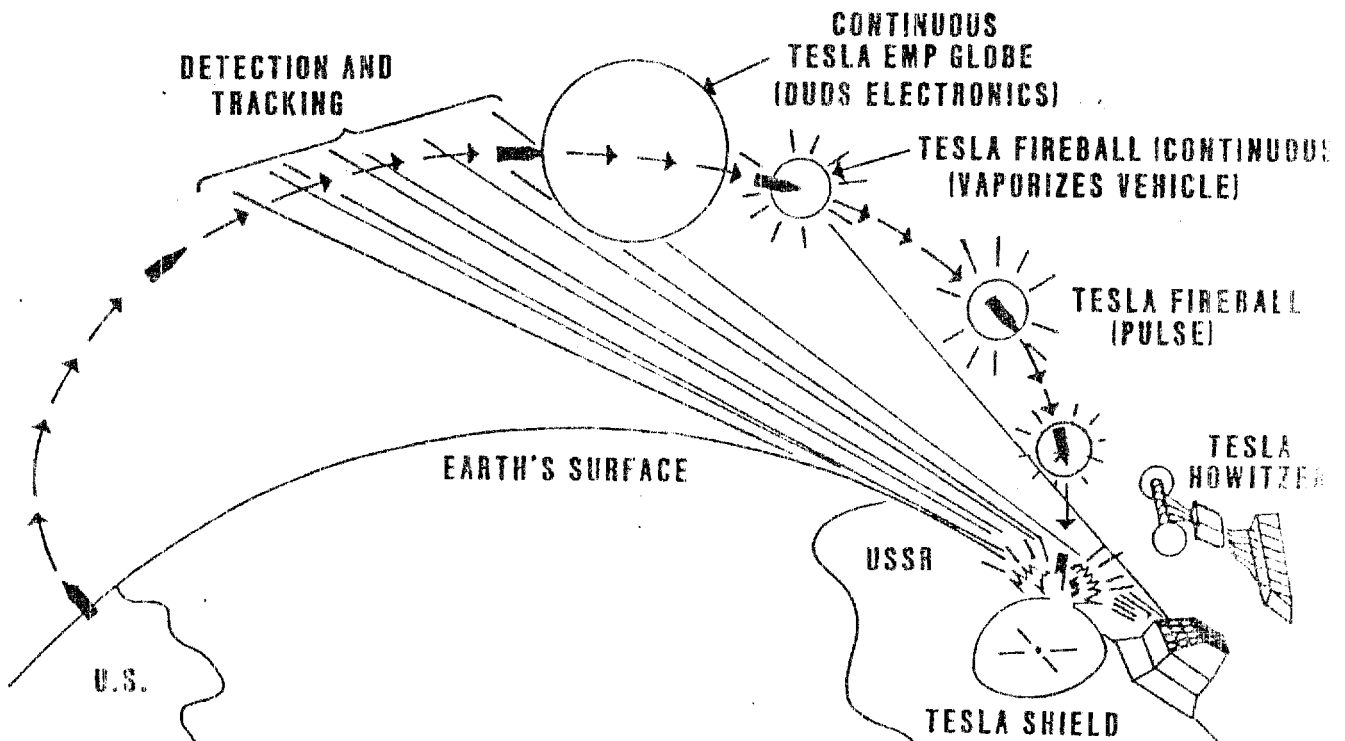

Item 11.

HEMISPHERE AND GLOBES 1977

(NOT TO SCALE)

0855 GMT
24 MAR, 1977
23°05' N; 17°25' W
M.V. KINPURNIE CASTLE

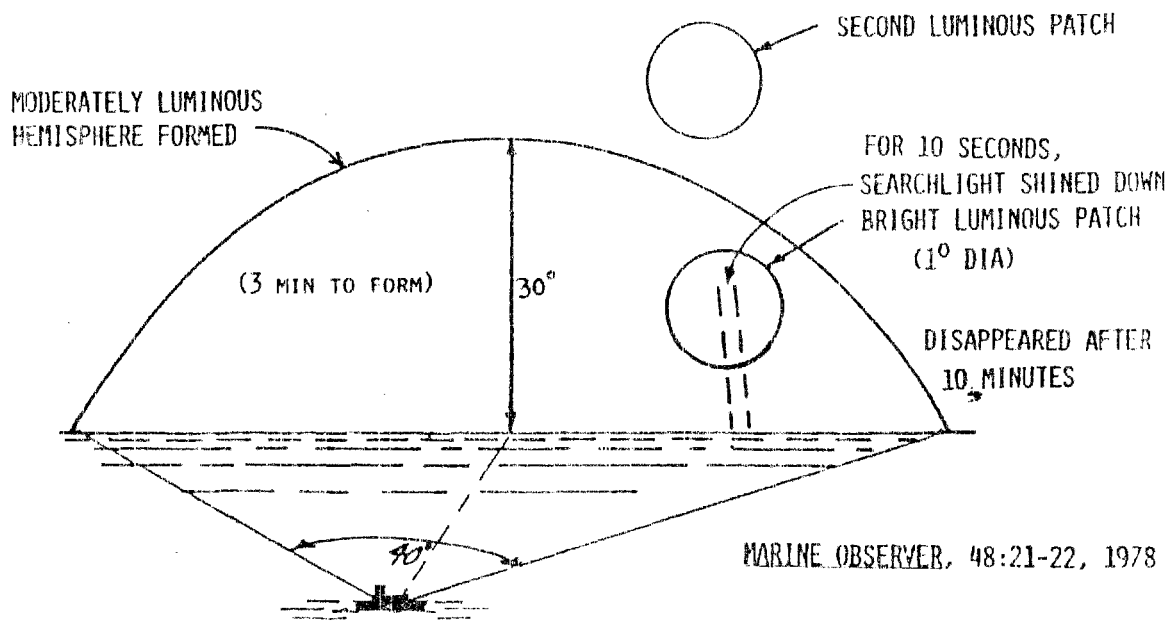

24 MAR 1977
NORTH ATLANTIC
0855 - 0902

- "SEARCHLIGHT" APPEARED 20° ABOVE HORIZON
- SHINED DOWN FOR 10 SECONDS
- EXTINGUISHED; REPLACED BY LUMINOUS PATCH 1° IN DIA.
- SEMICIRCLE OF MODERATE LUMINOSITY FORMED ABOUT PATCH (3 MIN)
- ANOTHER LUMINESCENT PATCH OBSERVED ABOVE SEMICIRCLE
- AFTER TOTAL OF 7 MIN, DISAPPEARED

Item 12. **EAST COAST AERIAL BLASTS
(HIGH BURST REGISTRATION?)**

DEC 77 -- JAN 78

- 2 DEC
 - 10:00 AM OFF SOUTH CAROLINA
 - 3:45 PM OFF NE COAST (NJ AND CONN)
- 15 DEC
 - 8:30 -- 10:30 AM FIVE BLASTS OFF SOUTH CAROLINA
- 20 DEC
 - EVENING -- 3 LOUD EXPLOSIONS, BALL OF FIRE (CONN)
- 21 DEC
 - 2:00 AM LOUD EXPLOSION AND INTENSE GLOBULAR LIGHT IN SKY (NJ) (SMOKE DETECTOR WENT OFF SECONDS BEFORE)
 - 7:00 PM EXPLOSIONS OVER SEACOAST (NJ)
- 22 DEC
 - 1 NEW JERSEY
 - 8:15 CHARLESTON, SC
- 13 JAN
 - 2:00 PM LOUD BOOMS, CHARLESTON, SC

Item 13. **BOOMS IN DELAWARE**

16 NOV 1982

- FIVE MYSTERIOUS MORNING BOOMS
 - 8:06, 8:07, 8:11, 8:12
 - 8:45
- WITHIN 39-MINUTE PERIOD
- ROCKED SUSSEX COUNTY
- RECORDED ON GEORGETOWN SEISMOGRAPHS
- NO SUPERSONIC FLIGHTS

Item 14. **1969 VIRGIN ISLANDS INCIDENT**

8:15 PM
THURSDAY
AUG 1969
VIRGIN ISLANDS
SEEN BY MANY RESIDENTS

Possible Tesla shield.

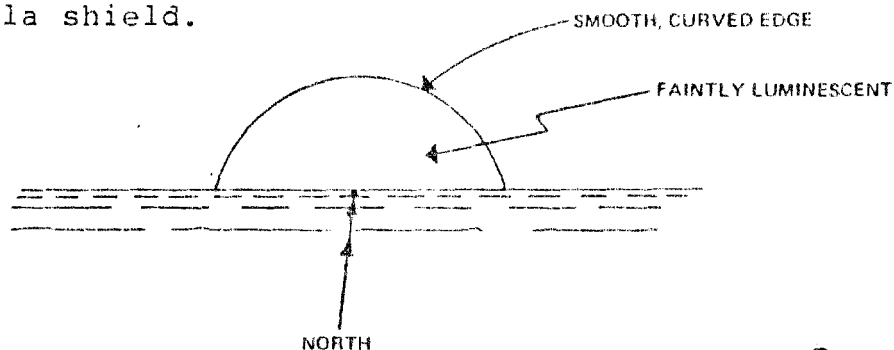

LUMINOUS ARC

22 AUG 1969
WEST INDIES

- LUMINOUS AREA SIGHTED
- BEARING 310 DEGREES
- GREW IN SIZE, ROSE IN ALTITUDE
- TURNED INTO ARCH OR CRESCENT

MARINE OBSERVER 40:107, 1970

Item 15. EXPANDING DOME-LIKE PHENOMENON

MAR 20, 1969
CARIBBEAN AND WESTERN
NORTH ATLANTIC

MARINE OBSERVER 40:17, 1970

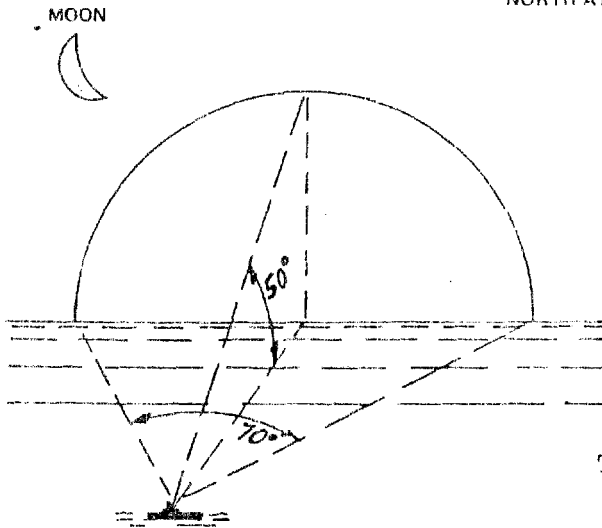

- SEMICIRCLE
- MILKY WHITE LIGHT
- QUITE BRIGHT AT FIRST
- DIMMED AS ENLARGED
- LASTED 10 MINUTES

Tesla shield.

Item 16. TWO ARCS IN THE SKY

MARINE OBSERVER 32:64, 1962

1800 GMT
JUNE 1, 1961
INDIAN OCEAN

Double concentric
Tesla Shields.

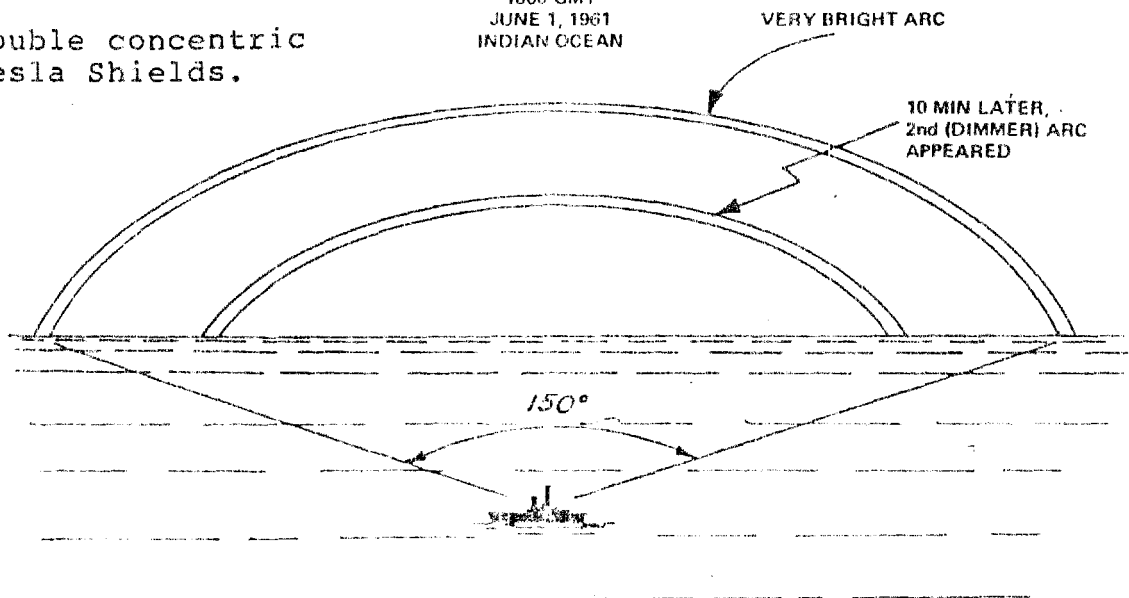

LASER BLINDING OF U.S. SATELLITES

- AT LEAST FOUR INCIDENTS IN LATTER 1975
- TWO USAF SATELLITES IN ELLIPTICAL ORBIT
 - INFRARED SENSORS WENT DOWN
 - ONE BLINDED UP TO FOUR HOURS
 - POSITIONING AND INTERFERENCE SUGGEST OPERATIONAL DEPLOYMENT
- SOVIET TECHNOLOGICAL BREAKTHROUGH ON THE ORDER OF
 - LITHIUM FUSION
 - SPUTNIK
- SUCH A LASER WOULD REQUIRE
 - LONG RANGE INFRARED CAPABILITY
 - PULSES OF VERY LONG DURATION
 - EXTRAORDINARY POINT ACCURACY
 - IF MOBILE, A MINIATURE POWER SUPPLY: A BREAKTHROUGH OF THE FIRST MAGNITUDE
- U.S. RECON SATELLITES AND PHOTO INTERPRETERS FAILED TO LOCATE ANY LASER OR POWER SUPPLY

Item 18. EXTREME INTENSITY SKY BRIGHTENING

WESTERN ALASKA

15 MAY 1972

- WEATHER: OVERCAST
- ENTIRE SKY SUDDENLY BRIGHTENED TO FULL DAYLIGHT INTENSITY
- LIKE A SUDDEN FLASHBULB
- LASTED ABOUT 2 - 7 SECONDS
- TWO CLOSELY-SPACED FLASHES NOTED
- CHANGED COLOR
 - BLUE TO GREEN TO WHITE
 - FADING TO ORANGE OR REDDISH

Item 19. **RADAR INVISIBILITY**

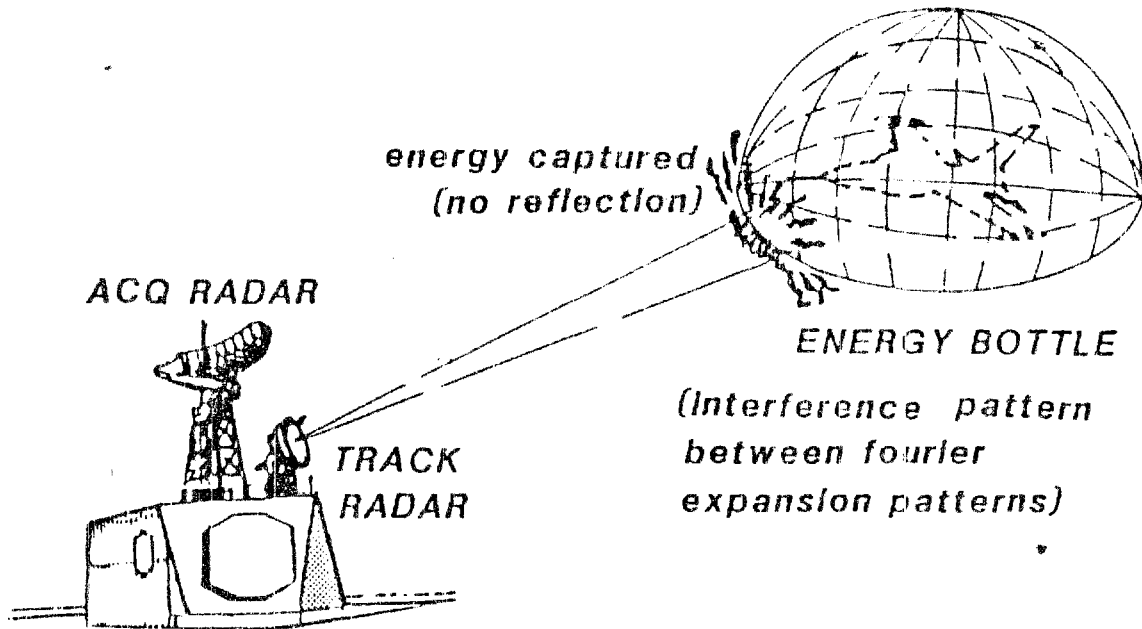

Item 20. **CREATING AN INERTIAL FIELD (ANTIGRAVITY)**

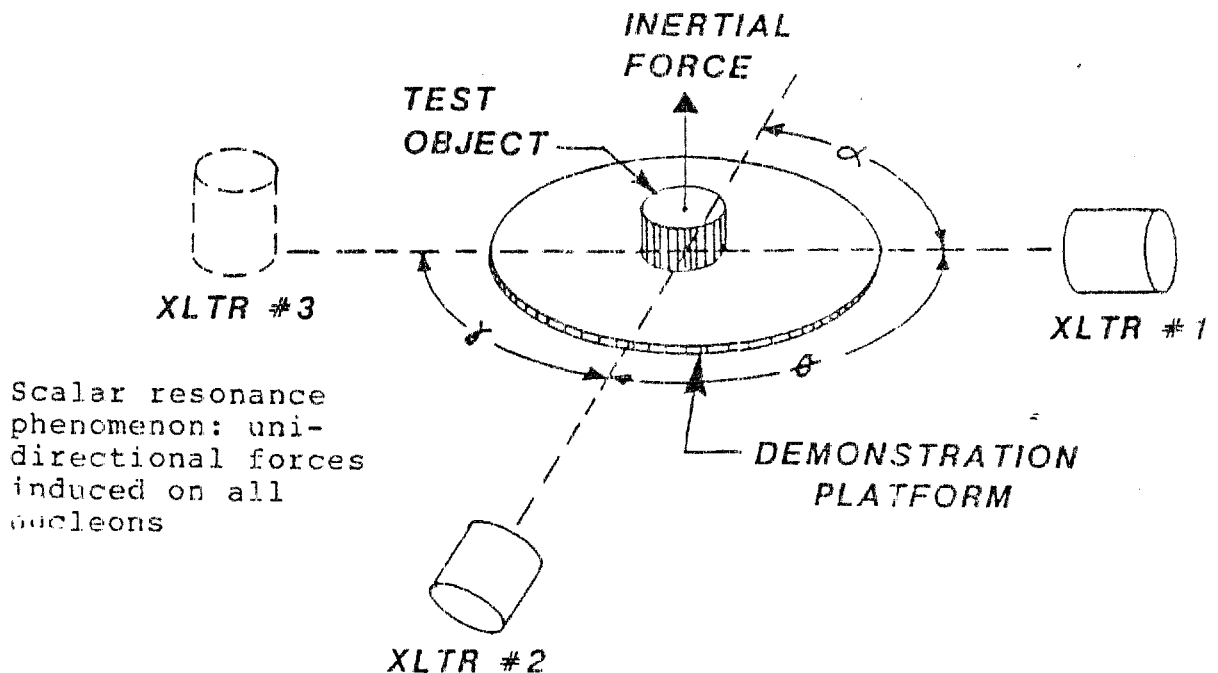

LIGHTNING WALL

1959-1960
PATROL PLANE COMMANDER
U.S. NAVY P5 AIRCRAFT
ATLANTIC OCEAN
200 M. EAST OF NORFOLK

REPORT FROM
PRIVATE FILES OF
T. E. BEARDEN

- COURSE OF 270 DEGREES
- APPROACHED "SOLID WALL OF LIGHTNING"
- FROM VERY HIGH ALTITUDE TO NEAR THE WATER
- NORTH-SOUTH AS FAR AS COULD SEE
- RADAR SCOPE CLEAR
- RIGGED AIRCRAFT FOR HEAVY WEATHER
- PLUNGED DIRECTLY THROUGH WALL
- WALL WAS VERY THIN
- CLOUDLESS SKY

Item 22. **ANOMALOUS BURNS AND UNDERWATER SOUNDS**

- UNDERWATER, OFF CORNWALL
- SEALS AND FISH DISCOVERED
 - DYING
 - MYSTERIOUS BURN MARKS
- DIVERS AND REPORTERS INVESTIGATED
 - HEARD SOUNDS UNDER WATER
 - VOICES IN FRENCH, ENGLISH, RUSSIAN
 - CLASSICAL MUSIC (BRAHMS, RACHMANIOFF)
 - UNNERVING BUZZING
 - THICK BLACK SLUDGE
 - YELLOWISH MATTER
- ENGLISH CHEMICAL WARFARE STATION ON COAST AT THIS POINT

Item 23.

"CLOUD ARC"

Tesla dome effect.
May have been an ice
test in endothermic
mode.

STRAIT OF GIBRALTAR
JULY 12, 1980
1825 GMT

"A MOST PECULIAR CLOUD ARC"
MARINE OBSERVER 51:
107-108, 1981

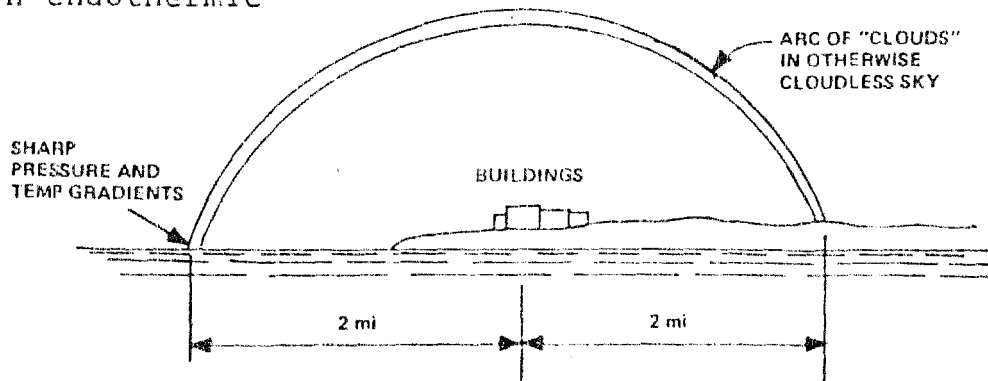

Item 24.

NEEDED: IMMEDIATE CRASH PROGRAM

- INFORMATION GATHERING
- COLLATION
- PHENOMENOLOGY
- THEORY
- EXPERIMENTS
- ENGINEERING DESIGN
- COUNTERMEASURES